



Ultrasound Diagnostic System

Model

ECO1 VET

ECO3 VET

V1.8

Jan 19, 2015

OPERATION MANUAL

Direction: CHUM ECO-001

Regulatory Requirement



This product conforms to the essential requirements of the Medical Device Directive 93/42/EEC. Accessories without the CE mark are not guaranteed to meet the Essential Requirements of the Medical Device Directive.

This manual is a reference for the ECO 1 VET/ECO 3 VET. Please verify that you are using the latest revision of this document. If you need the latest revision, contact your distributor.

NOTE:

Important

- 1.No part of this manual may be reduced, modified, copied or reprinted, in whole or in part, without written permission from CHISON.
- 2.The contents of this manual are subject to change without prior notice and without our legal obligation.
- 3.Before operating the system, please read and understand this manual. After reading, keep this manual in an easily accessible place. If you have any question or doubt, please contact CHISON's authorized service engineer.
- 4.CHISON's Warranty only cover material and parts costs for repair, but do not cover any labor cost or onsite service cost at end user's side.

NOTE:

Important information

1. It is the customer's responsibility to maintain and manage the system after delivery.
2. The warranty does not cover the following items, even during the warranty period:
 - a) Damage or loss due to misuse or abuse with system and probes, for example, drop the probe, the liquid or the metal part fall into the system.
 - b) Damage or loss caused by Acts of God such as fires, earthquakes, floods, lightning, etc.
 - c) Damage or loss caused by failure to meet the specified conditions for this system, such as inadequate power supply, improper installation or environmental conditions.
 - d) Damage or loss caused by non approved transportation by CHISON.
 - e) Damage or loss due to use the system outside the region where the system was originally sold.
 - f) Damage or loss involving the system purchased from a source other than CHISON or its authorized agents.
3. Do not make changes or modifications to the software or hardware of this system and probes.
4. During operate the system, if user has any doubt, difficulty or any unclear, please contact CHISON's authorized service engineer immediately. Please describe the situation clearly to solve the question in time. Before solve the question, please don't operate the system.
5. This system shall not be used by persons other than fully qualified and certified medical personnel.
6. The System modified or repaired by people other than CHISON's qualified service engineers, CHISON shall not be liable for the system.
7. The purpose of this system is to provide physicians with data for clinical diagnosis. It is the physician's responsibility for diagnostic procedures. CHISON shall not be liable for the results of diagnostic procedures
8. This manual contains warnings regarding foreseeable potential dangers, but user shall always be alert to dangers other than those indicated as well. CHISON shall not be liable for damage or loss that results from negligence or from ignoring the precautions and operating instructions described in this operation manual.
9. Due to negligence not following operation manual, CHISON shall not be liable for

the results.

10. Each time before and after ultrasound examination, please check the probe surface, probe cable and sheath whether they are abnormal, such as cracking, peeling and deformation. Also check whether the lens is strongly fixed. Abnormal probes may cause electric shock and injure the patient. Once any abnormal, user must stop using and contact CHISON's authorized service engineer.

11. If the probe is dropped or scratched by hard part, please stop using the probe immediately. And contact CHISON's authorized service engineer to make sure the safety and effectiveness is in good condition before use.

12. If there is any liquid or metal to enter to the system, please power off the system and stop using it immediately. Please first contact CHISON's authorized service engineer to make sure it's safe before restart using it.

13. Please don't use solvents (such as paint thinner, benzine, or alcohol) or abrasive cleansers for cleaning the system (including monitor and probes, etc). It may corrode the system and probes.

14. While the system or probe is over life time, please refer to operation manual section 9.4

15. Important data must be backed up on external memory media. CHISON shall not be liable for loss of data stored in the memory of this system caused by operator error or accidents.

16. Please put this operation manual with the system to ensure operator and manager can reach it at any time.

17. LCD display screen may have some dark or light dots, it is normal for the LCD. It does not mean that LCD screen is defective.



Caution: The users should read the operation manual carefully before operating the devices. Turning on the device means the users have read the operation manual and accept the listed cautions, warnings, and notes in the manuals. If the users disagree and cannot accept the cautions, the users can ask for returning the device.

Content

Chapter 1 Introduction.....	1
1.1 System Overview	1
1.2 Contact Information	1
Chapter 2 System Safety	2
2.1 Safety Overview.....	2
2.2 Electrical Safety.....	3
2.3 Labels	5
2.4 Patient Environmental Devices	6
2.5 Biological Safety	8
2.6 Scanning Patients and Education	9
Chapter 3 System Introduction	11
3.1 Console Overview.....	11
3.2 Physical Specification.....	11
3.3 System View in Different Views.....	12
3.4 Function Introduction.....	13
3.5 Installation Procedures.....	15
Chapter 4 Control Panel	21
4.1 Alphanumeric Keyboard	21
4.2 Function Keys/Knob	21
4.3 Central Control	24
4.4 The key of Image Mode	25
4.5 Control of Image	26
Chapter 5 Operation and Exam Mode	29
5.1 Preparing the System for Use.....	29
5.2 Choose Exam Mode.....	29
5.3 Patient Data Entry	30
5.4 Image Interface Display	31
5.5 Display Mode	31

5.6 Image Adjustment	32
5.7 B Image Menu Adjustment	34
5.8 Full Screen Show (need to activate this function in setup)	36
5.9 Edit Comment	36
5.10 Set Body Mark	38
5.11 Set the Direction of Arrow	39
5.12 Image and Cine Disposition	40
5.13 Image Browse	41
5.14 Archive Management	42
5.15 Report	44
5.16 DICOM	45
Chapter 6 Measurement and Calculation.....	47
6.1 Keyboard for Measurement	47
6.2 B Mode general Measurement methods	48
6.3 Normal measurement and calculation in B mode	50
6.4 Canine measurement and calculation	51
6.5 Feline measurement and calculation	52
6.6 Equine measurement	53
6.7 Bovine Measurement and Calculation	53
6.8 Ovine Measurement and Calculation	54
6.9 Normal Measurement and Calculation in M, B/M mode	54
6.10 General Measurement in M mode	56
6.11 Canine Measurement in M Mode	56
6.12 Feline Measurement in M Mode	56
6.13 Equine Measurement in M Mode	56
6.14 Bovine Measurement in M Mode	56
6.15 Ovine Measurement in M Mode	56
Chapter 7 Preset.....	57
7.1 General setting	57
7.2 Measurement	58

7.3 Annotation	67
7.4 Body marks	69
7.5 Exam Mode	70
7.6 Keyboard.....	72
7.7 DICOM	73
7.8 NET Work	75
7.9 System	75
Chapter 8 System Maintenance	77
8.1 Machine Clean.....	77
8.2 Probe Maintenance	77
8.3 Safety Check	79
8.4 Malfunction Check.....	79
Chapter 9 Probes	80
9.1 General Description	80
9.2 Care and Maintenance.....	80
9.3 Probe Operation Instructions	90
9.4 Service Responsibility	90
Appendix A: Acoustic Output Report Table	92
Appendix B: Guidance and Manufacturer’s Declaration.....	110
Appendix C: Measurement Results Summary.....	114
Appendix D: Display Accuracy and Acoustic Measurement Uncertainties.....	116
Appendix E: Transducer Maximum Surface Temperature	117

Chapter 1 Introduction

This manual contains necessary information for safe system operation.

Read and understand all instructions in this manual before operating the system. Always keep this manual with the equipment, and periodically review the procedures for operation and safety precautions.

1.1 System Overview

Indications for Use

The device is a general-purpose ultrasonic imaging instrument intended for use by a qualified physician for evaluation of ABD, OB, GYN, Vessel, Small Parts, MSK/PT, Nerve, Big animal, Reproduction, Small animal cardiac.

Contraindication

The system is NOT intended for Ophthalmic use or any use that causes the acoustic beam to pass through the eye.

1.2 Contact Information

For additional information or assistance, please contact your local distributor or the appropriate support resource shown below:

CHISON website www.chison.com

Service Support CHISON Medical Imaging Co., Ltd.

Tel:0086-0510-85311707

Fax: 0086-0510-85310726

E-mail: service@chison.com.cn

Placing an Order CHISON Medical Imaging Co., Ltd.

Tel: 0086-0510-8531-0593/0937

Fax: 0086-0510-85310726

Email: export@chison.com.cn

Manufacturer CHISON Medical Imaging Co., Ltd.

No.228, ChangJiang East Road, Block 51 and 53 Phase 5 Industrial Park,
ShuoFang, New District, Wuxi, Jiangsu, China, 214142

Chapter 2 System Safety

2.1 Safety Overview

This section discusses measures to ensure the safety of both the operator and animal. To ensure the safety of both operator and patient, please read the relevant details in this chapter carefully before operating this system. **Disregarding the warnings or violation of relevant rules may result in personal injury or even loss of life for operator or patient.**

Users should observe the following precautions:

- This system complies with Type BF general equipment, and the IEC standard.
- Do not modify this system in any way. Necessary modifications must be made only by the manufacturer or its designated agents.
- This system has been fully adjusted at the factory. Do not adjust any fixed adjustable parts.
- In the event of a malfunction, turn off the system immediately and inform the manufacturer or its designated agents.
- The power cable of the system should only be connected to a grounded power socket. Do not remove the ground cable for any reason.
- Only connect this system, either electronically or mechanically, with devices that comply with the EN60601-1 standard. Recheck the leakage current and other safety performance indices of the entire system to avoid potential system damage caused by leakage from a current superposition.
- The system does not incorporate any specialized protective measures in the event it is configured with high-frequency operation devices. The operator should use caution in these types of applications.
- The system should be installed only by personnel authorized by the manufacturer. Do not attempt to install the system by yourself.
- Only an authorized service engineer may perform maintenance.
- Only a qualified operator, or someone under qualified supervision, should use the system.
- Do not use this system in the presence of flammable substances, otherwise an explosion may occur.
- Do not continuously scan the same part of a patient or expose the patient to prolonged scanning, otherwise it may harm the patient.
- When using the system for ultrasound testing, use only qualified ultrasound gel that complies with system standards.
- Do not unplug probe when the system is in active operation. Always go to EXAM screen

when need to remove the probe.

- To prevent from arm or neck injury, the operator should not stay at the same position for too long during patient scanning without taking break.
- Do not put liquid on top of the main unit.

⚠NOTE

**To dispose of this product properly, please call your local service department.*

2.2 Electrical Safety

Type of protection against electric shock

- **Class I Equipment**

CLASS I EQUIPMENT in which protection against electric shock does not rely on BASIC INSULATION only, but includes a protective earth ground. This additional safety precaution prevents exposed metal parts from becoming LIVE in the event of an insulation failure.

⚠NOTE: The mains supply shall be cut off after disconnecting the power line and the net power.

Degree of protection against electric shock

- **Type BF Applied part** (for Probes marked with BF symbol)

TYPE BF APPLIED PART providing a specified degree of protection against electric shock, with particular regard to allowable LEAKAGE CURRENT

Level of protection against harmful ingress of water

- Parts of **probe** likely to come into contact with **operator** or **patient** meet the requirements of **drip-proof equipment (IPX1)**

Parts of **probe** intended to be immersed in **normal use** meet the requirements of **watertight equipment (IPX7)**

- The IP Classification of System is Ordinary Equipment (IPX0)

Safety level when used in the presence of FLAMMABLE ANAESTHETIC MIXED WITH AIR (or WITH OXYGEN or WITH NITROUS OXIDE):

The Equipment is not suitable for use in the environment with FLAMMABLE ANAESTHETIC MIXED WITH AIR (or WITH OXYGEN or WITH NITROUS OXIDE)

Mode of operation

- Continuous Operation

For maximum safety, always follow these guidelines:

- Proper grounding of the system is critical to avoid electrical shock. For protection, ground the chassis with a three-wire cable and plug, and plug the system into a hospital-grade, three-hole outlet.
- Do not remove or circumvent the grounding wire.
- Do not remove the protective covers on the system. These covers protect users from hazardous voltages. Cabinet panels must remain in place while the system is in use. A qualified electronic technician must make all internal replacements.
- Do not operate this system in the presence of flammable gases or anesthetics.
- All peripheral devices (unless certified as medical grade) that are connected to the system must be powered through the electrical outlet through an optional isolation transformer.

Notice upon Installation of Product

Separation distance and effect from fixed radio communications equipment: field strengths from fixed transmitters, such as base stations for radio (cellular/cordless) telephones and land mobile radios, amateur radio, AM and FM radio broadcast, and TV broadcast transmitter cannot be predicted theoretically with accuracy. To assess the electromagnetic environment due to fixed RF transmitters, an electromagnetic site survey should be considered. If the measured field strength in the location in which the ultrasound system is used exceeds the applicable RF compliance level as stated in the immunity declaration, the ultrasound system should be observed to verify normal operation. If abnormal operation is observed, additional measures may be necessary, such as re-orienting or relocating the ultrasound system or using an RF shielded examination room may be necessary.

- Use either power supply cords provided by or designated by CHISON. Products equipped with a power source plug should be plugged into the fixed power socket which has the protective grounding conductor. Never use any adaptor or converter to connect with a power source plug (e.g. three-prong-to-two-prong converter).
- Locate the equipment as far away as possible from other electronic equipment.
- Be sure to use only the cables provided by or designated by CHISON. Connect these cables following the installation procedures (e.g. wire power cables separately from signal cables).
- Lay out the main equipment and other peripherals following the installation procedures described in this manual.

Notice against User Modification

The user should never modify this product.

User modifications may cause degradation in Electrical Safety . Modification of the product includes changes in:

- Cables (length, material, wiring, etc.)

- System configuration/components

User modifications may cause degradation in EMC performance. Modification of the product includes changes in:



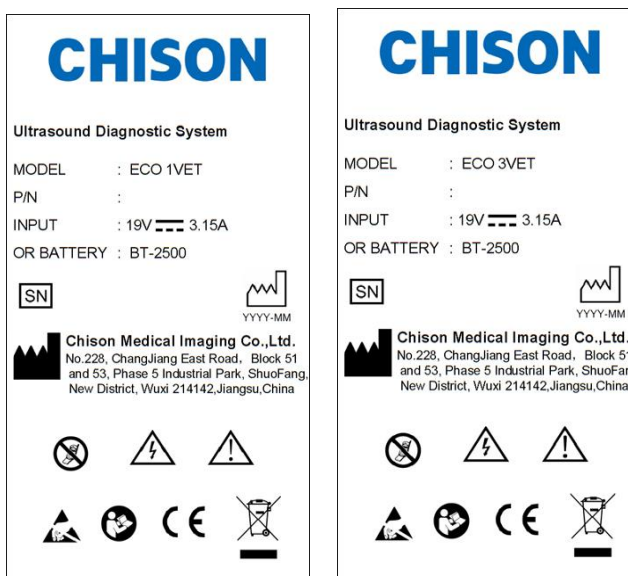

- Cables (length, material, wiring, etc.)
- System installation/layout
- System configuration/components
- Securing system parts (cover open/close, cover screwing)











2.3 Labels



Real panel label

2.3.1 Warning Symbols

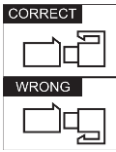
 <p>Caution, consult accompanying documents. This symbol advises the reader to consult the accompanying documents for important safety related information such as warnings and pre-cautions that can not be presented on the device itself.</p>	 <p>Dangerous electric voltage. Unplug the main plug before opening the system!</p>
 <p>Do not use the following devices near this equipment: cellular phone, radio receiver, mobile radio transmitter, radio controlled toy, etc. Use of these devices near this equipment could cause this equipment to perform outside the published specifications. Keep power to these devices turned off when near this equipment.</p>	 <p>Be careful of static.</p>

 <p>WASTE OF ELECTRICAL AND ELECTRONIC EQUIPMENT (WEEE): This symbol is used for Environment Protection, it indicates that the waste of electrical and electronic equipment must not be disposed as unsorted waste and must be collected separately. Please contact your local Authority or distributor of the manufacturer for information concerning the decommissioning of your equipment.</p>	 <p>Type-BF applied part</p>
 <p>This symbol is followed by the serial number of the device.</p>	 <p>MANUFACTURER: This symbol is accompanied by the name and the address of the manufacturer.</p>
 <p>Power On/off. CAUTION: This Power Switch cannot isolate Mains Supply completely.</p>	 <p>This symbol signifies that the user manual must be read.</p>
 <p>The “Alternating current” symbol indicates that the equipment is suitable for alternating current only.</p>	 <p>The CE mark of Conformity indicates this equipment conforms with the Council Directive 93/42/EEC</p>
 <p>CORRECT: The correct connection of the battery connector WRONG: The wrong connection of the battery connector</p>	 <p>This symbol is followed by the manufacturing date of the device in the form YYYY-MM.</p>

2.4 Patient Environmental Devices

Left side:

- 1 LAN port
- 1 VGA port: External monitor
- 2 USB ports
- 1 Footswitch port
- 1 Power in port

Rear panel:

- 2 Probe ports
- 1 USB port

- 1 Video out port
- 1 Remote port

Acceptable Devices

The Patient Environmental devices shown above are specified to be suitable for use within the PATIENT ENVIRONMENT.

⚠CAUTION:

- DO NOT connect any probes or accessories without approval by CHISON within the PATIENT ENVIRONMENT.

DO NOT touch patient and devices without IEC/EN 60601-1 approval to avoid the leakage current risk within the PATIENT ENVIRONMENT.

Unapproved Devices

⚠CAUTION:

- DO NOT use unapproved devices.
- If devices are connected without the approval of CHISON, the warranty will be INVALID.
- The system can't be used with HF surgical equipment, otherwise the burns to patient may occur.

Any device connected to this system must conform to one or more of the requirements listed below:

- IEC standard or equivalent standards appropriate to devices.
- The devices shall be connected to PROTECTIVE EARTH (GROUND).

⚠CAUTION:

Unsafe operation or malfunction may result. Use only the accessories, options and supplies approved or recommended in these instructions for use.

Peripheral used in the patient environment

The system has been verified for overall safety, compatibility and compliance with the following on-board image recording devices:

B/W video printer: Sony UP-D711MD

The system may also be used safely while connected to devices other than those recommended above if the devices and their specifications, installation, and interconnection with the system conform to the requirements of IEC/EN60601-1-1.

Adapter is considered as a part of ME equipment

The connection of equipment or transmission networks other than as specified in the user instructions can result in an electric shock hazard or equipment malfunction. Substitute or alternate equipment and connections require verification of compatibility and conformity to IEC/EN 60601-1-1 by the installer. Equipment modifications and possible resulting malfunctions and electromagnetic interference are the responsibility of the owner.

General precautions for installing an alternate off-board, remote device or a network would include:

- The added device(s) must have appropriate safety standard conformance and CE Marking.
- There must be adequate mechanical mounting of the device and stability of the combination.
- Risk and leakage current of the combination must comply with IEC/EN 60601-1.
- Electromagnetic emissions and immunity of the combination must conform to IEC/EN 60601-1-2.

Peripheral used in the non-patient environment

The system has been verified for compatibility, and compliance for connection to a local area network (LAN) via a wire LAN, provided the LAN components are IEC/EN 60950 compliant.

General precautions for installing an alternate off-board, remote device or a network would include:

- The added device(s) must have appropriate safety standard conformance and CE Marking.
- The added device(s) must be used for their intended purpose having a compatible interface.

2.5 Biological Safety

This product, as with all diagnostic ultrasound equipment, should be used only for valid reasons and should be used both for the shortest period of time and at the lowest power settings necessary (**ALARA** - As Low As Reasonably Achievable) to produce diagnostically acceptable images. The AIUM offers the following guidelines:

Clinical Safety Quoted from AIUM

*Approved March 26,
1997*

Diagnostic ultrasound has been in use since the late 1950s. Given its known benefits and recognized efficacy for medical diagnosis, including use during human pregnancy, the American Institute of Ultrasound in Medicine herein addresses the clinical safety of such use:

There are no confirmed biological effects on patients or instrument operators

caused by exposures from present diagnostic ultrasound instruments. Although the possibility exists that such biological effects may be identified in the future, current data indicate that the benefits to patients of the prudent use of diagnostic ultrasound outweigh the risks, if any that may be present.

2.6 Scanning Patients and Education

The **Track-1** or **IEC60601-2-37** output display standard allows users to share the responsibility for the safe use of this ultrasound system. Follow these usage guidelines for safe operation:

- In order to maintain proper cleanliness of the probes, always clean them between patients.
- Always use a disinfected sheath on all EV/ER probes during every exam.
- Continuously move the probe, rather than staying in a single spot, to avoid elevated temperatures in one part of the patient's body.
- Move probe away from the patient when not actively scanning.
- Expose the patient to only the very lowest practical transmit power levels for the shortest possible time to achieve a satisfactory diagnosis (**ALARA** - As Low As Reasonably Achievable).
- In any case, maximum MI and TI are less than 1.0.

2.6.1 Safe Scanning Guidelines

- Ultrasound should only be used for medical diagnosis and only by trained medical personnel.
- Diagnostic ultrasound procedures should be done only by personnel fully trained in the use of the equipment, in the interpretation of the results and images, and in the safe use of ultrasound (including education as to potential hazards).
- Operators should understand the likely influence of the machine controls, the operating mode (e.g. B-mode) and probe frequency on thermal and cavitation hazards.
- Select a low setting for each new patient. Output should only be increased during the examination if penetration is still required to achieve a satisfactory result, and after the Gain control has been moved to its maximum value.
- Maintain the shortest examination time necessary to produce a useful diagnostic result.
- Do not hold the probe in a fixed position for any longer than is necessary. The frozen frame and Cine loop capabilities allow images to be reviewed and discussed without

exposing the patient to continuous scanning.

- Do not use endo-cavitary probes if there is noticeable self heating of the probe when operating in the air. Although applicable to any probe, take particular care during trans-vaginal exams during the first eight weeks of gestation.
- Take particular care to reduce output and minimize exposure time of an embryo or fetus when the temperature of the mother is already elevated.
- Take particular care to reduce the risk of thermal hazard during diagnostic ultrasound when exposing: an embryo less than eight weeks after gestation; or the head, brain or spine of any fetus or neonate.
-  Warning against activation of **transducer assembly** intended for intra-corporeal use outside **patient's** body if **transducer assembly** does not comply with **emc** requirements (may cause harmful interference with other equipment)

Chapter 3 System Introduction

3.1 Console Overview



Console Overview

3.2 Physical Specification

335mm (Length) ×155mm (Width) ×350mm (Height)

3.3 System View in Different Views

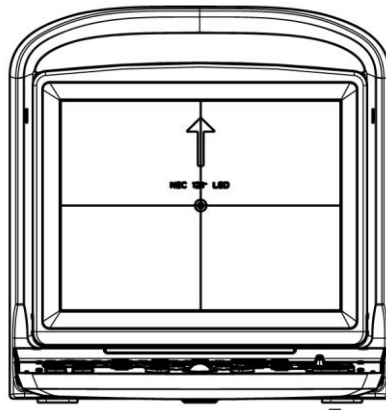

System Front View

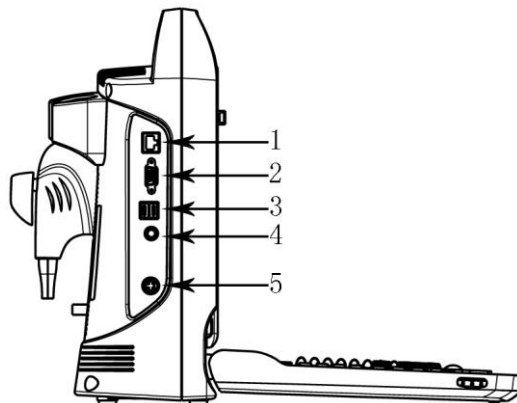

System Side View

1.Ethernet 2.VGA 3.USB 4.Footswitch 5.Power in

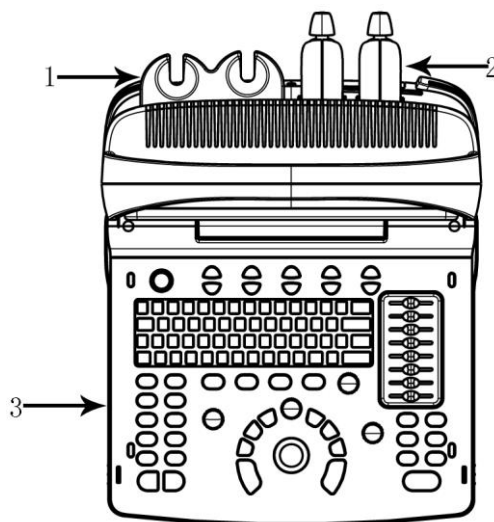

Console Overview

1.Probe Holder 2.Probe 3.Keyboard

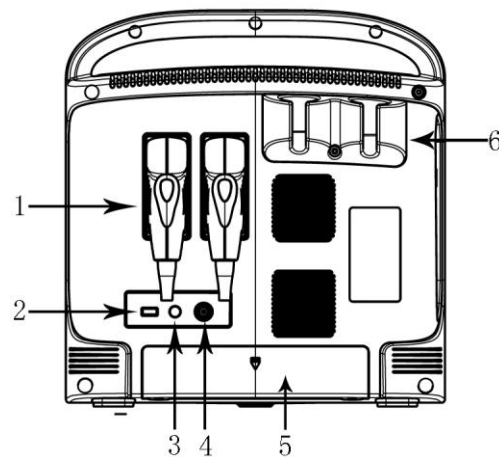

System Rear View

1. Probe 2. USB 3. Remote 4. Video Out 5. Battery Holder 6. Probe Holder

3.4 Function Introduction

1. Possess B, B/B, 4B, B/M, M display mode M, B/M mode possess 4 kinds of scan velocity;
2. Possess many combination of focus, total gain control 8 segments STC;
3. Possess depth scan and image left-right up-down rolling-over function;
4. Possess a lot of imaging technology for example multiple compound imaging (space frequency compound), multiple frequency, multiple zoom ratio, pan zoom, screen scroll, chroma, harmonic imaging etc;
5. Possess image processing, total gain, dynamic range, frequency, focus number, focus position, zoom, compound, scan width, line density, smooth, edge enhancement, frame, persistence, gray scale, restrain boost multi-beam, acoustic power, M velocity;
6. Possess distance proportion circumference volume rate angle histogram in B mode distance time velocity heart rate measurement function in M mode ;GYN measurement software package, small parts measurement software package, ventricle function measurement software package and user defined formula;
7. Possess body mark arrow case number display, real time clock display annotation in image user-defined annotation;
8. Possess multi-language interface display User interface change, shear plate, printing ,DICOM3.0 biopsy guided functions;
9. It has permanent storage for image and cine and optional 320GB HDD. It can also be connected to removable storage via USB port. To realize mass storage ,can recall saved image for analysis;
10. Cine loop storage 256frames real time image;
11. Screen rotation function make you adjust screen angle according to users' requirement 0~30°;
12. Output standard PAL or NTSC video signal and VGA signal;
13. Print or export graphic report.

3.4.1 Image Modes

- B mode
- B/M mode
- M mode

- 2B mode
- 4B mode

3.4.2 Accessories

Transducers:

 <p>C3-A, 2.5-5.0MHz Convex Array Indications for Use: ABD, OB, GYN,URO</p>	 <p>L7M-A, 5.3-10.0MHz Linear Array Indications for Use: Vessel, Small Parts, Equine Tendon</p>
 <p>L7S-A, 5.3-11.0MHz Linear Array Indications for Use: Vessel, Small Parts, Equine Tendon</p>	 <p>MC6-A, 4.5-8.0MHz Micro-convex Array Indications for Use: Canine Abdomen, Feline Abdomen, Small Animal Cardiac</p>
 <p>L7V-A Linear Array, 5.3-10.0MHz Linear Array Indications for Use: Big Animal, Reproduction</p>	 <p>MC5V-A, 4.0-7.0MHz Micro-convex Array Indications for Use: Canine Abdomen, Feline Abdomen,</p>

Peripherals

VGA output for external monitor

VIDEO output for B&W video printer

LAN port output

LAN for DICOM and image review station

USB 2.0 for flash drive

Foot switch

AC/DC adapter: MDS-060AAS19 B

Input: 100-250V~1.5-0.75A, 50-60Hz

Output: 19V=3.15A

DELTA ELECTRONICS, INC.

Battery Pack: BT-2500, 4400mAh, DONGGUAN POWER INC

3.4.3 Configuration of the System

Configuration	ECO1 VET	ECO3 VET
Color	Grey/White	Black/White
Probe	1(standard), 2(option)	2(standard)
Maximum memory	8GB	8GB

320G HDD	No	Option
Built in battery	Option	Standard
Compound, i-Image, SRA,THI	Standard	Standard
Trapezoidal	No	Standard
Chroma	Standard	Standard
DICOM 3.0	Option	Option
Graphic Printer	Option	Option: HP LaserJet P2055d, HP LaserJet P1102, HP LaserJet Pro 200 color M251n
Probe configuration	Six: C3-A, L7M-A, L7S-A, MC6-A, MC5V-A, L7V-A	Six: C3-A, L7M-A, L7S-A, MC6-A, MC5V-A, L7V-A

3.5 Installation Procedures

 **Note:** Please do not turn on the power switch until finishing all the installation and necessary preparation.

3.5.1 Environment Condition

The system should be operated under the following environment.

3.5.1.1 Operation Environment Requirement

Ambient Temperature: 10 °C ~ 40 °C

Relative Humidity: 30% ~ 75%RH

Atmospheric Pressure: 700hPa ~ 1060hPa

3.5.1.2 Transport and Storage Environmental Requirement

The following environmental transport and storage conditions are within system tolerances:

Temperature: -5° C ~ 40° C

Relative Humidity: ≤ 80% non-condensing

Atmosphere Pressure: 700hPa ~ 1060hPa

3.5.1.3 Electrical Requirements

Power Consumption: less than 60 VA

Voltage Fluctuation

 **WARNING**

Maintain a fluctuation range of less than ±10% of voltage labeling on rear panel of the system, otherwise the system may be damaged.

Grounding

Before connecting the power cable, connect the attached ground protection cable from Equipotentiality terminal on system rear panel to a specialized grounding device.

NOTE

- *Please follow the outlined power requirements. Only use power cables that meet the system guidelines—failure to follow these procedures may produce system damage.*
- *Line power may vary in different geographic locations. Refer to the detailed ratings on the rear panel of the system for detailed information.*
- **Battery**

To avoid the battery bursting, igniting, or fumes from the battery; causing equipment damage, observe the following precautions: Do not immerse the battery in water or allow it to get wet. Do not put the battery into a microwave oven or pressurized container. If the battery leaks or emits an odor, remove it from all possible flammable sources. If the battery emits an odor or heat, is deformed or discolored, or in a way appears abnormal during use, recharging or storage, immediately remove it and stop

using it. If you have any questions about the battery, Short term (less than one month) storage of battery pack: Store the battery in a temperature range between 0 degrees C (32 degrees F) and 50 degrees C (122 degrees F).

Long term (3 months or more) storage of battery pack: Store the battery in a temperature range between -20 degrees C (-4 degrees F) and 45 degrees C (113 degrees F); Upon receipt of the ECO VET and before first time usage, it is highly recommended that the customer performs one full

discharge/charge cycle. If the battery has not been used for >2 months, the customer is recommended to perform one full discharge/charge cycle. It is

also recommended to store the battery in a shady and cool area with FCC (full current capacity).

• One Full Discharge/Charge Cycle Process: 1. Full discharge of battery to let the ECO VET automatically shut down. 2. Charge the ECO VET to 100% FCC (full current capacity). 3. Discharge of Venue 40 for complete shut down (takes one hour for discharge). • When storing packs for more than 6 months, charge the pack at least once during the 6 month timeframe to prevent leakage and deterioration in performance.

3.5.1.4 Operation Space

Please leave enough free space from the back of the system to ensure well ventilation.

 **Caution:** Leave enough free space from the back of the system, Otherwise, with the increasing of the temperature inside the unit, malfunction may occur.

3.5.1.5 System Positioning & Transporting

Moving the System

When moving or transporting the system, take the precautions described below to ensure maximum safety for personnel, the system and other equipments.

Before Moving the System

- Press  3 s, system will forced shut down and completely switch off the system.
- Disconnect all cables from off-board peripheral devices (external printer, etc.) from the console.

⚠NOTE

To prevent damage to the power cord, DO NOT pull excessively on the cord or sharply bend the cord while wrapping it.

- Store all probes in their original cases or wrap them in soft cloth or foam to prevent damage.
- Replace gel and other essential accessories in the appropriate storage case.
- Ensure that no loose items are left on the console.

When Moving the System

- Carry the system with handle, or put the system on the cart to move it.

⚠NOTE

Walk slowly and carefully when moving the system.

Do not let the system strike walls or doorframe.

Transporting the System

Use extra care when transporting the system in a vehicle. After preparing the system as described above, take the following additional precautions:

- Only use vehicles that are suitable for transport of the system.
- Before transporting, place the system in its original storage carton.
- Load and unload the system to a vehicle parked on a level surface.
- Load the unit aboard the vehicle carefully and over its center of gravity. Keep the unit still and upright.
- Ensure that the transporting vehicle can bear the weight of system plus the passengers.
- Secure the system firmly with straps or as directed within the vehicle to prevent movement during transport. Any movement, coupled with the weight of the system, could cause it to break loose.
- Drive carefully to prevent damage from vibration. Avoid unpaved roads, excessive

speeds, and erratic stops or starts.

3.5.2 Powering the System

3.5.2.1 Acclimation Time

After being transported, the unit requires one hour for each 2.5 ° increment if its temperature is below 10 °C or above 40 °C.

NOTE

Please keep at least 20 to 30 cm spare space away from the back of the system to ensure well ventilation. Otherwise, with the increasing of the temperature inside the unit, malfunction may occur.

3.5.2.2 Connecting the electric power

After making sure that the AC power supply in hospital is in normal status, and this AC voltage type matches to the power requirements indicated on the label of system, then please connect the plug of power cord to the POWER IN socket at the rear panel of the system, and connect the other end of power cord to the AC power supply socket in hospital.

Please use the power cable provided by the manufacturer, other type of power cable is not allowed.

Press  1 s, system boot,

press  and pop up dialog for shut down. Click the enter key then power off.

or press  3 s, system will forced shut down

CAUTION

Connecting the system to the wrong AC power supply may cause damage to the system and danger to the operators and animals.

3.5.3 Probe Installment

Caution: Please only use the probes provided by manufacturer for this model, other types of probes are not allowed to use with this system! Otherwise it may cause the damage to the system and the probe.

CAUTION

Before connecting the probe, please carefully check the probe lens, probe cable and probe

connector to see whether there is anything abnormal, such as cracks, falls off. Abnormal probe is not allowed to connect to the system; otherwise there is possibility of electricity shock.

- Hold the probe connector lock switch, and insert the connector socket vertically.
- Release the probe lock switch.
- Check the locked probe with one hand to make sure that it's not loose, and it's securely connected

⚠CAUTION

- Only power supply at “turn off” state, can install / take-down the probe, otherwise it will damage the machine or the probe.
- When installing and disassembling probe, please put the probe head inside the probe holder, it can prevent the probe falling down to the ground.

3.5.3.1 Probe Disassembly

Turn the dead lock switch 90degree in counterclockwise direction, extract probe connector plug vertically.

3.5.4 Accessories Installment

⚠Caution: Please only use the optional parts provided or suggested by manufacturer! Using other types of optional devices may cause the damage to the system and the connected optional devices.

3.5.4.1 Video printer installment

- 1.Put video printer stably.
- 2.Connect cable of video printer to video port in the back of the device. And connect the other side to video signal output port in the rear side.
- 3.Connect the printer line to print control port in the printer rear side, And connect the other side to the print control port in the unit rear side.
- 4.Connect power cable of video printer to power system..
- 5.Adjust printer parameter preset according to the type of printing paper

⚠Caution: Do not use any other power cable to replace 3-wire power cable manufacturer provides, otherwise there is danger of electric shock.

Video printer sign introduction

 : Video signal input port

 : Video signal output port

 : Print control port

 : Video printer switch

3.5.4.2 Graphic printer installment

Put graphic printer stably, connect printer cable to USB port in the left side of the unit.
Connect the power cable of graphic printer to power system.

 **Caution:** Please see packing list for fundamental configuration!

Chapter 4 Control Panel

4.1 Alphanumeric Keyboard

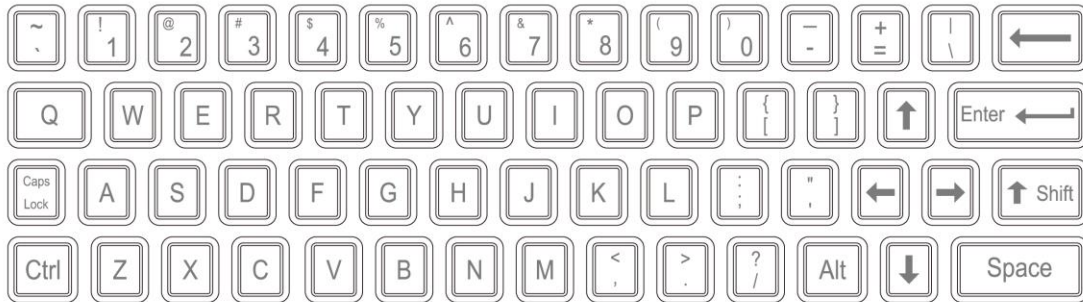

Alphanumeric Keyboard

The alphanumeric keys are used for inputting patient number, name, character and figure etc.

4.2 Function Keys/Knob

4.2.1 SWITCH



Turn on or off the device

4.2.2 PATIENT



Set up a new patient data, input name and other information.

4.2.3 PROBE



Press this button for selecting probe. It can only select the connected probe.

4.2.4 SETUP



Press this button to get in or out the system setting page.

4.2.5 END



Press END key to finish the exam.

4.2.6 BODYMARK



Press this key to enter into body mark working status, select the body mark and confirm the probe scanning position on the screen. It is only available in frozen status.

4.2.7 COMMENT



Press this key to enter into comment status, and add comments in the image area on the screen.

4.2.8 ARROWS



Add arrows key to the image area.

4.2.9 DEL



Press this key to clear the measurement lines, body mark, and comments.

4.2.10 Print

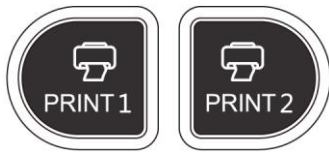

PRINT1: Print the screen image by video printer connected to the system.

PRINT2: Print the report by printer connected to the system (Only report page works). Or print the image in the scanning page; Or print the image in the review page.

4.2.11 Archive



File management of system, you can view and edit the patient data.

4.2.12 Report



Produce/ Save/ Recall an examination report.

4.2.13 Parameter Control Button

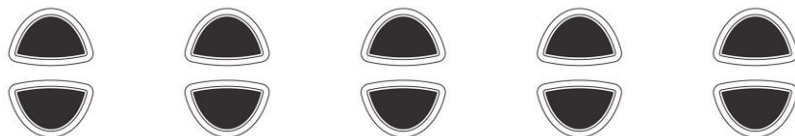

Increase/decrease the corresponding parameters of the screen, Or open/close the function.

4.3 Central Control

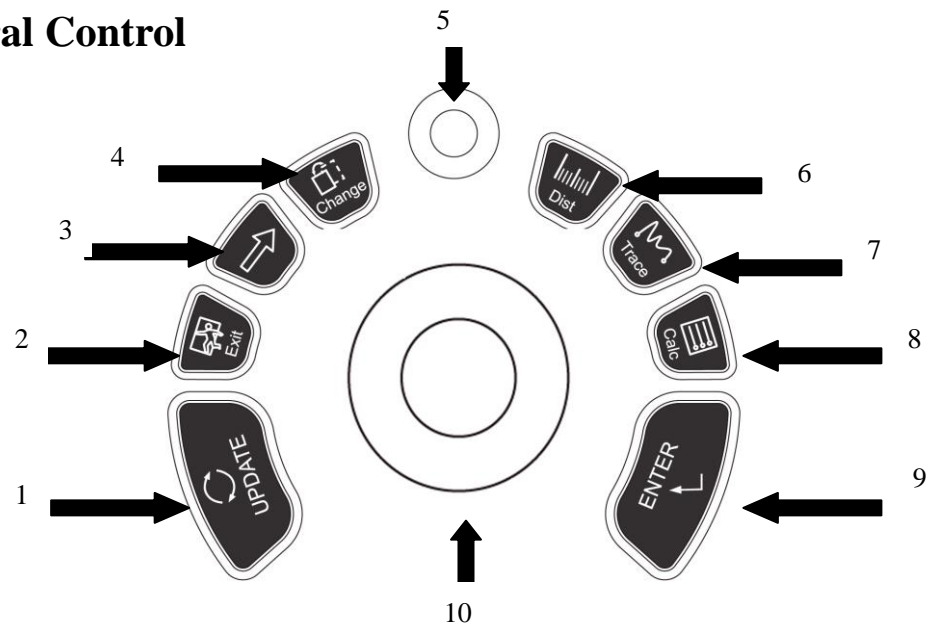

1. UPDATE 2.EXIT 3.Cursor 4.Change 5.MENU
6. Dist 7.Trace 8.Calc 9.ENTER 10.Trackball

4.3.1 ENTER

This multifunction key is work with trackball. The function switches with the unit status. Such as, set the cursor position, body mark position, comment position, toggle trackball function, selected the menu, and confirm the input.

4.3.2 UPDATE

This multifunction key is work with trackball. The function switches with the unit status. Such as, call the annotation and back in measuring.

4.3.3 Exit

Press this key can exit measurement, dialog, and menu.

4.3.4 Cursor

Press this key to show or hide the cursor.

4.3.5 Change

Press this key to change the menu.

4.3.6 Dist

Press this key to enter into distance measurement.

4.3.7 Trace

Press this key to enter into trace or ellipse measurement, and press **UPDATE** to change between trace and ellipse.

4.3.8 Calc

Press this key to enter into measurement software package.

4.3.9 MENU

Press MENU-knob for second time to select the item and adjust the parameters. Press MENU-knob for third time to exit from current item. Rotate the MENU- knob to select the item

4.3.10 Trackball

Trackball is the main operation tool on screen. Position calipers in measurement, the function of the trackball is different under diverse working status.

4.4 The key of Image Mode

4.4.1 B



Display B mode

4.4.2 B/B



Press this key to enter into 2B mode.

4.4.3 4B



Press this key to enter into 4B mode.

4.4.4 M



Press this key to change the mode between B/M and M.

4.5 Control of Image

4.5.1 THI



Press this key to open or close the THI function.

4.5.2 AIO



Only press this key for automatic optimization image.

4.5.3 CINE



Only press this key to save the current cine loop.

4.5.4 SAVE



Only press this key to save the current image.

4.5.5 Left and Right Invert



Press this key to invert the image from left and right.

4.5.6 Up and Down Invert

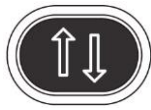

Press this key to invert the image from up and down.

4.5.7 STC

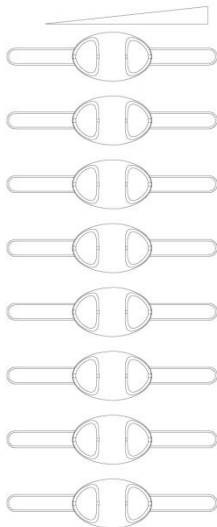

STC can be used for adjusting gain compensation in different image depth.

4.5.8 GAIN

Rotate the knob to adjust the gain of B mode and M mode.

4.5.9 ANGLE/ZOOM Knob

Rotate the knob to adjust the angle or zoom. Press this knob to change the function between angle and zoom.

4.5.10 DEPTH/FOCUS Knob

Press the knob to adjust the depth and function position. Press the knob to change the function between depth and focus position.

4.5.11 Information Area Indicating Machine Status



Left-to-Right of the up row: hard disk, cable network, USB

●Hard disk: press this icon to show the capacity of disc to used save data or USB flash disk in

current system

- Cable network: show the present situation of cable network; press this icon to show the IP address of current system.
- USB: show whether this system connects USB flash disk or not, press this icon to show USB safely remove interface.

Left-to-Right of the down row: input method, DICOM Task Sequence, battery gauge

- Input method: press this icon to switch Chinese and English input method.
- Task manager: press this icon to show DICOM Task Sequence and its situation ,To terminate the DICOM task, delete, and so on (Need to activate DICOM)
- Battery gauge: show the connecting situation of the battery, just press this icon to show the present State of charge and discharge, remaining electric quantity and available time.

4.5.12 Indicator Light



From left to right: Adapter Indicator, Charge Indicator, Sleep Indicator.

- Adapter Indicator: when the main unit connects to the adapter with power supply, the indicator lights, otherwise extinguishes.
- Charge Indicator: When the battery is charging, the indicator lights, Once the battery is charged, the indicator goes out.
- Sleep Indicator: When the main unit is in sleep mode, the indicator lights, otherwise extinguished.

Chapter 5 Operation and Exam Mode

This chapter mainly describes the process of the normal operation of the device, including the preparation before examination, how to get the image, optimize the image, add comments, body mark and so on.

5.1 Preparing the System for Use

5.1.1 The Device Inspection

- (1)The device is placed stability;
- (2) The grid voltage AC 100-240V, 50Hz-60Hz;
- (3)Cable is properly connected, firm and ground, the adapter is properly connected to the device;
- (4)Probe is connected and fixed.

5.1.2 Power On

Long press  1 second to start the machine, wait for the system to enter the user interface, activate the probe slot into the B-mode.

5.2 Choose Exam Mode

5.2.1 The Probe Identification

The system default automatically identify the current probe type, When the probe is inserted, Press



to switch the probe.

 **CAUTION:** Please connect or disconnect the probe only after the system is freezing, in order to ensure stability and extend the service life of the probe.

5.2.2 Mode Selection

In probe selection interface, probe and clinical application selection page is displayed, you can choose needed probe and inspection part, and press the default into the B-mode, start scan detection.

NOTE: The system has been set clinical application pre-set before leaving factory, each probe has its own pre-set.

The detailed operation steps of the clinical application pre-set of the probe, please refer to the pre-set section.

5.3 Patient Data Entry

Press the  to display the Patient screen

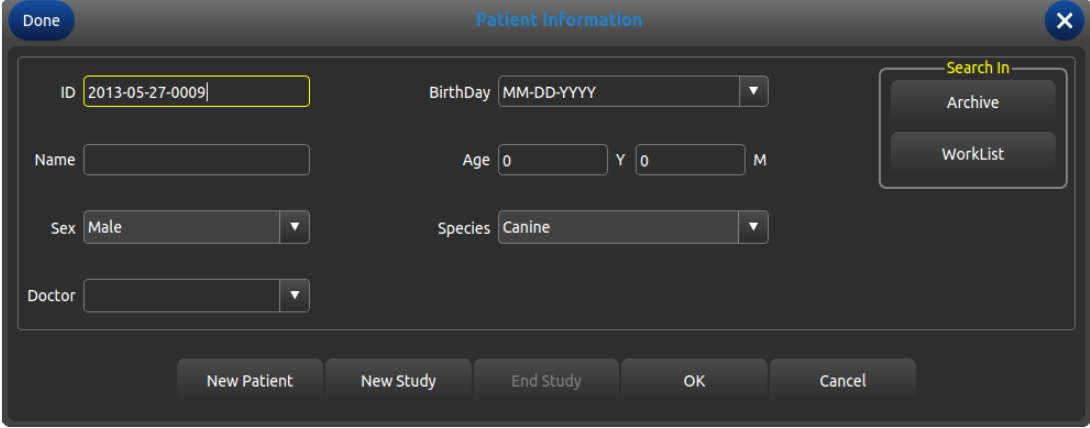

Patient's Information Screen

Function Buttons on Patient screen:

[Archive]: Operation on the patient information which has already existed;

[Wordlist]: Recall patient information in worklist. And need to open the DICOM function;

[New Patient]: Create a new patient information identity;

[New Study]: Choose exam applications for the new patient;

[End Study]: Edit patient's exam item;

[OK]: Save patient information;

[Cancel]: Cancel the operation of new patient information;

Operation Methods:

(1) Move the Trackball to the position of inputting character, then input patient information by character keyboard.

(2) Use the Trackball and the **[ENTER]** key to switch between different input options: ID, patient name, doctor's name, birthday (It can be automatically calculated when input age), age (It can be automatically calculated when input birthday), gender.

(3) Select the exam items, and input the regular inspection information.

(4) After inputting the required information, click on the **OK** button to save the patient information, the system will return to the B-mode.

(5) Recall information of the previous patient, you can use the **Archive** or **Worklist** to recall patient information to exam.

 **CAUTION:** Creating a diagnostic record, you should check the accuracy of the patient information before saving measurement or image; otherwise, it will be stored in the wrong patient records. After checking the patient, press the **[END]** key to save the patient information in the system.

5.4 Image Interface Display

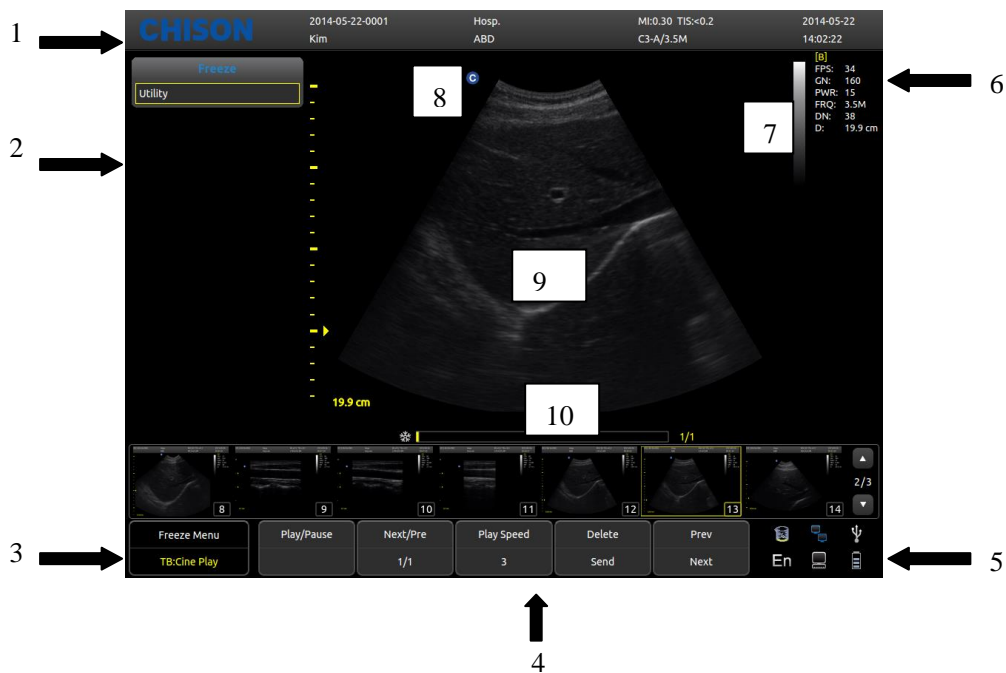

- 1, Logo 2, Control menu 3, Image status prompt 4, Image parameter area
 5, System state prompt 6, Image parameter area 7, Gray-scale strip
 8, Start point of scanning 9, Image Region 10, Cine loop

5.5 Display Mode

Display Mode: B,2B,4B,M,B/M, they can be shifted by the mode key.

5.5.1 B Mode

Press **[B]** Mode key, and display the single B Mode image, B Mode is the basic mode for two-dimensional scanning and diagnosis.

5.5.2 B/B Mode

Press **[2B]** to display double B mode images side by side. One image is in real-time status; the other is in frozen status. The real-time image has start scan marker and ruler marker. Press **2B** button in **[B/B]** mode, the original active image is frozen while the original frozen image is activated.

5.5.3 4B Mode

Press **[4B]** button to enter into 4B mode, the screen will display four B mode images side by side, but only one image is in real-time status. Pressing it again can switch the real-time status among four images.

5.5.4 B/M Mode

Press **[B/M]** button, a real time B-mode image and a real-time M-mode image will be displayed at the same time. And a sample line will appear in the B-mode image area, which indicates the active sample position for M image on the B image area. Click the position on the B image area to fix the position of sampling line.

5.5.5 M Mode

Press **[M]** button again, B mode image will disappear; M mode image is still active on the whole screen. M mode image stands for the tissue movement status at the sampling line. The M mode image varies with time, so it is mainly used for cardiac applications.

5.6 Image Adjustment

5.6.1 Frequency

In real status, press the first line button of **[frequency]** to increase the frequency, and press the second line button of **[frequency]** to decrease the frequency.

5.6.2 Dynamic

Dynamic range is used for adjusting the contrast resolution of B mode image and mode image, compressing or enlarging the display range of gray scale.

At the real-time status, press the first line button of **[Dynamic]** to increase the Dynamic, and press the second line button of **[Dynamic]** to decrease the Dynamic. The range is 30 to 90.

5.6.3 i-Image

In real status, press the corresponding button of **[i-Image]** to adjust, the range is 0~3.

5.6.4 Compound

In real status, press the corresponding button of **[compound]** to adjust, and the range is 0~3. The SRA can't be edited after opening the compound.

5.6.5 SRA

In real status, press the corresponding button of **[SRA]** to turn on or off.

5.6.6 M Speed Adjustment

In real M status, press the corresponding button of **[Speed]** to adjust M speed, and the range is 1~4.

5.6.7 Gain

In real status, rotate [Gain] button to adjust the Gain, and the range is 0~255, the step is 5.

5.6.8 STC

STC curves can be used for adjusting gain compensation in different image depth.

Drag the slide of STC to adjust the value.

STC curve will disappear automatically 1 second later after stopping adjustment.

5.6.9 Depth

Press [DEPTH/FOCUS] selection knob until the indicator of [DEPTH] is lit, then rotate the knob to change the depth of image.

5.6.10 Focus Pos

Press the [DEPTH/FOCUS] selection knob until the indicator of [FOCUS POS] is lit. Then turn the knob to change Focus Position.

5.6.11 ANGLE/ZOOM

Press [ANGLE/ZOOM] button until the indicator of [ANGLE] is lit, and the angle of sample gate will rotate with the rotation direction.

Press [ANGLE/ZOOM] button to confirm the ZOOM button is lit, and it will appear the zoom box, rotate the button to select the zoom steps.



5.6.12 INVERT

B mode image and B/M mode image can be reversed horizontally and vertically.

Press the  key, the displayed image is reversed in the right-left horizontal direction.

Press the  key, the displayed image is reversed in the up-down direction.

The horizontal flip status indicators of the upper-left corner of the image window have the following meanings:

The meaning of the symbol “” indicating the probe initiative scanning position “” situated in the left indicates that the first scanning line in the left of the screen is corresponding to the initiative scanning position of the probe,

“” situated in the right indicates that the first scanning line in the right of the screen is corresponding to the initiative scanning position of the probe.

5.6.13 THI(ECO1 VET Without THI)

Turn ON/OFF THI

5.6.14 AIO

Only press this key to optimize image.

5.7 B Image Menu Adjustment

BMenu	
ScanWidth	100 %
Focus Num	1
Persistence	3
Density	High
Smooth	0
Edge	1
Acoustic Power	15
Utility	
Advance	

Click [**Change**] button or [**MENU**] button to display the menu.

Rotate [**MENU**] button or press [**Cursor**] button to display the cursor, and move the sample box to the corresponding function, press [**MENU**] button to update the function, then rotate [**MENU**] button to adjust the function, press [**MENU**] again to exit the function.

5.7.1 Scan Width

Select [**Scan Width**], and adjust the scan width to the corresponding size.

5.7.2 Focus Num

In B mode, 4 focus points can be selected simultaneously, and the number controlled by the depth, SRA and Compound.

Move the cursor to [**Focus Num**] selection to adjust, and the range is 1~4.

5.7.3 Persistence

In real status, adjust the contrast and resolution.

In real status, press the first line button of [**Persistence**] to adjust. The range is 0~7.

5.7.4 Line Density

Scan Line Density function is only valid for the image in B mode, B/B mode, B/M mode or 4B mode image. The line density has two types: high density and low density. High density means better image quality while low density image has higher frame rate.

To do the adjustment, please select the submenu item [**LINE DENSITY**] and press [**MENU**] to adjust the line density.

5.7.5 Smooth

Smoothness function is used for restraining the image noise and performing axial smooth processing to make the image smoother.

Move the cursor to [**Smoothness**] selection to adjust, and the range is 0~7.

5.7.6 Edge Enhance

Edge enhancement is used for enhancing the image outline. In this way the user can view the tissue structure more clearly.

Move the cursor to [**Edge**] selection to adjust, and the range is 0~7.

5.7.7 Acoustic Power

Acoustic power means the acoustic power transmitting from the probe.

At the real-time status, Move the cursor to [**Acoustic power**] selection to adjust, and the range is 0~15, and the least adjustable level is 1 dB/level.

5.7.8 Utility

This function includes post processing, slide show and other items. Press [**MENU**] button, then choose Utility selection, it will appear Utility options.

5.7.8.1 Post Processing

5.7.8.1.1 Chroma

Adjust the type of the chroma.

Update [**Chroma**], and rotate [**MENU**] button to select the Chroma type, the range is 0~31.

5.7.8.1.2 2D Map

Select the type of the scale curve.

Update [**2D Map**], and rotate [**MENU**] button to select the scale curve type, the range is 0~4.

5.7.8.1.3 B Gamma

Adjust image gray value parameters.

Update [**B Gamma**], and rotate [**MENU**] button to select the B Gamma parameters, the range is 0~8.

5.7.8.1.4 B Rejection

Adjust image gray scale inhibition parameters

Update [**B Rejection**], and rotate [**MENU**] button to adjust B Rejection parameters, the range is 0~256.

5.7.9 Advance

In B Mode, select **Advance**, after pressing [**MENU**] button, it will appear Advance options.

5.7.9.1 Zoom Coef

Adjust the size of the ruler.

Update [**Zoom Coef**], and rotate [**MENU**] button to adjust, the range is 60%~100%.

5.7.9.2 MB

Through opening MB to improve image quality

Press [**MENU**] to turn on or turn off the MB function.

5.7.9.3 Trapezoidal Mode

Press [**MENU**]to turn on or turn off the trapezoidal function.

5.7.9.4 Biopsy

Show or hide biopsy.

Press the [**MENU**] to show or hide biopsy line.

5.8 Full Screen Show (need to activate this function in setup)

Full screen the image area. Press [**Gain**] knob to activate the function; Press [**EXIT**] button to exit full screen show.

When full screen shows, press [**MENU**] knob to show the menu of current mode (except body mark, annotation, measurement).

5.9 Edit Comment

5.9.1 Overview

The comment is to enter text or symbols on the image, the device is Chinese and English annotation system.

ENTER COMMENT: Press  enter into comments status;

Exit COMMENT: Press  again or [**FREEZE**]key to exit;

Comment means input the words or symbols on images for making explanation. Add comments can through keyboard input directly or using the default comments.

The default comments are classified by examination mode as follows:

Classification	Function Description
Abdomen	Abdomen, general anatomy term

Obstetrics	Anatomy term of Obstetrics
Gynecology	Anatomy term of Gynecology
Heart	Anatomy term of Heart
Small Parts	Anatomy term of Small Parts
Lesion	Lesion term: Abdomen、Obstetrics、Gynecology、Heart、Small Parts

 **NOTE:** If you need to custom the default comments, refer to the pre-set section.

5.9.2 Input Characters

Operation:

1. Press  button, then system will go into the comment process.
2. Move the cursor to the position where need to comments.
3. Input characters at cursor position by keyboard then press [ENTER] key to confirm.
4. Press COMMENT-key again to exit. The COMMENT-key will light off and the comments process is finished.

5.9.3 Input Comment Library Characters

- 1、 In comment status, move trackball to image area to edit;
- 2、 Press[Font size]to adjust front size of comments, the range is 10~20;
- 3、 Rotate[MENU]to select needed comments, then press[MENU] to exit ;

5.9.4 Edit Quick Comments

- 1、 Press[Edit]to pop quick comment edit box;
- 2、 Input customized comments;
- 3、 Press[Done]to finish edit, press[X]to cancel edit;

5.9.5 Input Quick Comments

- 1、 Press[Text]to select needed quick comments;
- 2、 Adjust front size of comments;
- 3、 Press[Input]to place comments in the image area;

5.9.6 Move Comments

- 1、 In comment status, move trackball to the comment, press **ENTER** key to activate it;
- 2、 Move trackball to place the comment to target area;
- 3、 Press **ENTER** again to confirm the comment;

5.9.7 Edit Comments

- 1、 In comment status, move trackball to the comment, press **ENTER** key to activate it
- 2、 Press[BACKSPACE]to delete unnecessary characters;
- 3、 Press[ENTER]to confirm;

5.9.8 Delete Comments

5.9.8.1 Delete Characters

In comment status, activate the comment that need to be deleted, then press the **ENTER** key, it will display "|" on the screen, press[BACKSPACE]key to delete the character.

5.9.8.2 Delete Single Comment

Activate the comment that need to be deleted, press[DEL]to delete comment;

5.9.8.3 Delete All Contents of the Comment

Don't activate the single comment, press[DEL]to delete all characters that has input;

 **Caution:** Press[DEL]key, but it will delete the measurement and body mark at the same time;

5.9.9 Set the Position of Default Comment

Operation:

- 1、 Press[Save Home Pos.]to move cursor to the initial position;
- 2、 Press[Load Home Pos.]to set the initial position;

5.10 Set Body Mark

5.10.1 General Description

The body mark indicates Animal's examination position and the direction of probe scan on the image.

Body marks are divided into: Bovine, Canine, Equine, Feline and Ovine, each has different body mark. Each type of body mark automatically is corresponding to current examination mode.

Icon:



Bovine Mark



Canine Mark



Equine Mark





Feline Mark



Ovine Mark

5.10.2 Body Mark Operation

Operation:

- 1、 Press  to enter into the body status.
- 2、 Select the body mark that you need.
- 3、 Move trackball after adding the body mark image and then adjust the position of probe.
Rotate [MENU] or [ANGLE] knob can adjust the probe direction. Press Enter- key to confirm when adjustment was finished.
- 4、 Move the Trackball to change the position of the body mark;
- 5、 If you want to exit from the body mark function, press  again;
- 6、 Press [EXIT] to exit body status and the body mark is fastened to the screen.
- 7、 Press [DEL] to delete body marks.

5.11 Set the Direction of Arrow

Operation:

- 1、 Press  to display arrow;

- 2、 Press [**Change**] button to select cursor type: arrow or cross. And change the size of the cursor.
- 3、 Adjust the position of probe. Rotate [**MENU**] or [**ANGLE**] knob can adjust the probe direction.
- 4、 Press [**ENTER**] to confirm when adjustment was finished.
- 5、 Press[**EXIT**]to exit the arrow settings.
- 6、 Press[**DEL**]to clear the arrows has inputed,

5.12 Image and Cine Disposition

5.12.1 The Principle of Cine Storage

In real image status, the image can be stored in the movie memory in chronological order, maximum frames can be set. The maximum number of frames of the film storage can be set, please refer to pre-set chapter.

If the movie memory is full, the recent frame saved into memory, the previous frame removed from memory.

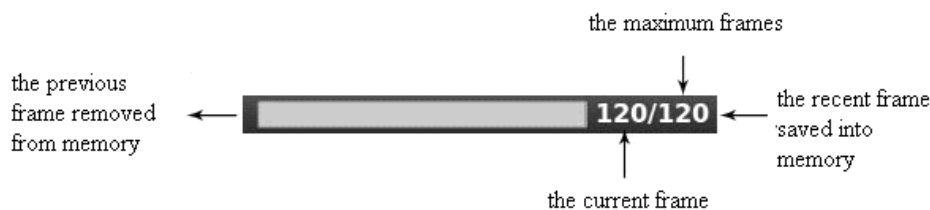

Cine loop indicate diagram

5.12.2 Manual Loop

Press[**FREEZE**]to freeze image, pop cine playback bar, at this time, move cursor to play by hand; Track ball rolling to the right, the loop play with ascending order side by side.

Or press[**Next/Pre**]to play.

5.12.3 Automatic Loop

After freezing image, press[**Play/Pause**]to play, press it again to stop.

Press [**ENTER**]to choose the are of automatic playback area needed.

5.12.4 Save and Recall Image

- 1.Press  to save current image, the image will be displayed below the screen;
- 2.If you need to recall images that has been stored, move cursor to needed image, press

[ENTER]to recall it; Or you can recall archived patient's information to recall image, please refer to archive chapter.

5.12.5 Save and Recall Cine

In freeze status, press  to save cine, then it will be displayed below the screen, move cursor to needed cine, press [ENTER]to recall cine.

5.12.6 Delete images

After recalling the images , press the [**Delete images**] to delete the files.

5.12.7 Send images

After recalling the images , press the [**Send images**] to send images to USB flash disk , DICOM storage and print.

Hint: Activate the DICOM before DICOM storage and print.

5.13 Image Browse

Press  to enter image information browsing interface. Press [ENTER]to any function in the image.

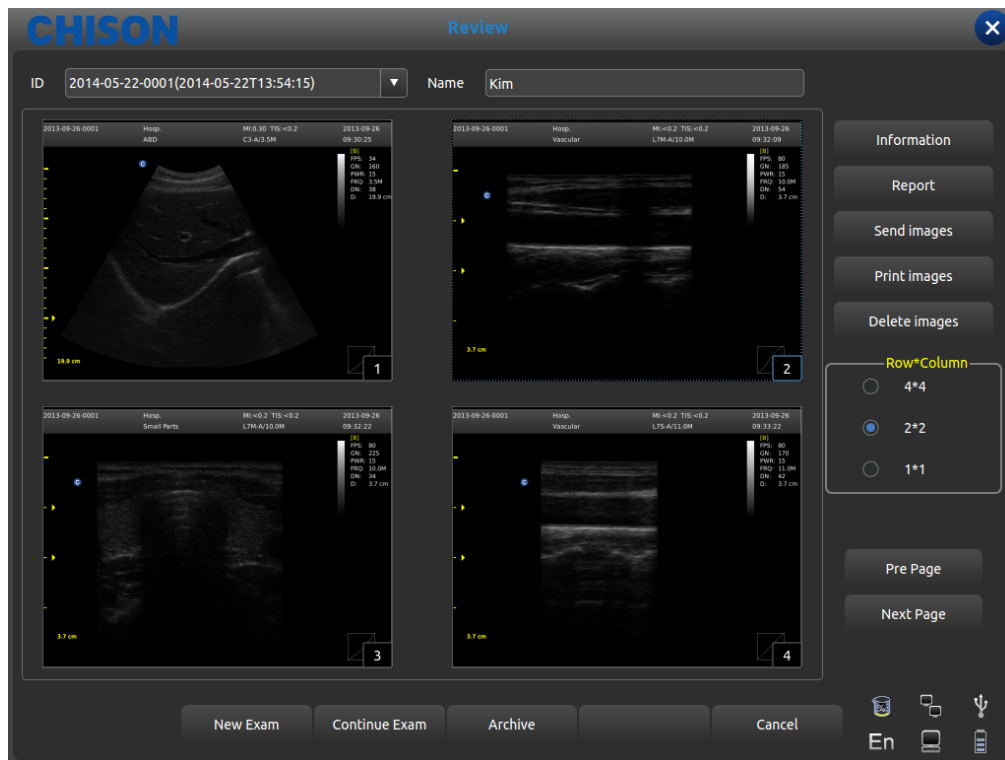

Review interface

- ID: ID of Current patient.
- Name: Current patient's name.
- Information: Enter into current patient's information interface.
- Report: Enter into current patient's report interface;
- Send images: Send image to USB flash disk , DICOM storage and print;
- Print the image: print the image which be chosen, it will be printed as the arrangement set;
- Delete images: Delete selected image;
- Row*Column: Select image's format;
- Pre page: Page up;
- Next page: Page back;
- New Exam: Exit current examination and open a new dialog box.
- Continue Exam: Exit image browsing interface and go on checking current patient;
- Archive: Open up archive management interface;
- Cancel: Turn off image browsing interface;

5.14 Archive Management

Archive management can search for patient's information which has been stored in system. Press [Archive]to archive management interface, all process can be opened up by moving cursor.

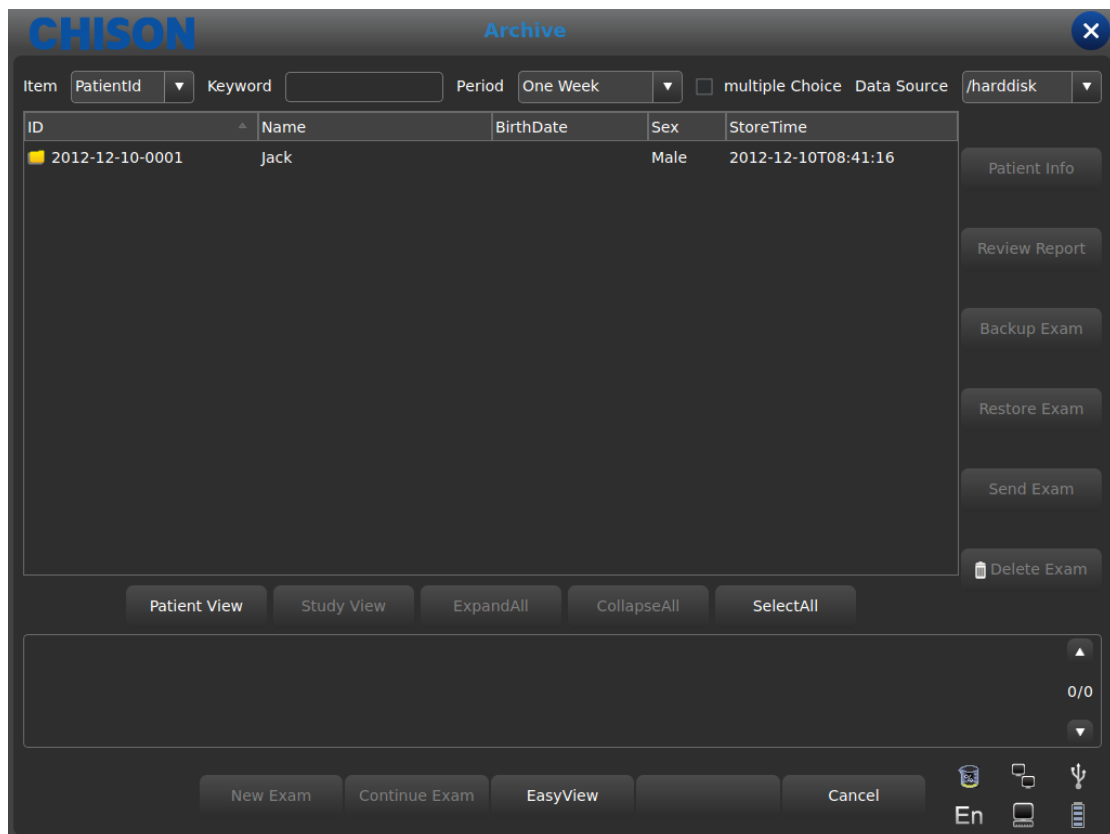

Archive interface

- Item: Type selection, select Patient's ID or Name;
- Keyword: Search for key words;
- Period: Time filter, select today、 one week、 one month、 three months、 six months, recent one year and all
- Multiple Choice: Multiple choice;
- Dada Source: Path choice, select hard disk or U disk;
- Patient info: Enter into patient's information interface;
- Review Report: Enter into report interface;
- Backup Exam: Select examination information to USB flash disk;
- Restore Exam: Recover examination information from USB flash disk;
- Send Exam: Send selected examination information to USB flash disk or DICOM Storage/Print (Need to activate the DICOM);
- Delete Exam: Delete selected examination information;
- Patient View: Change display mode of information;
- Expand All: Select Patient View, it will display sub-directory;
- Collapse All: Exit sub-directory;
- Select All: Select all examination information;
- New Exam: Exit current patient's examination;
- Continue Exam: Exit archive management interface and go on checking current patient;
- Easy View: Exit archive management interface and open up image browsing interface;
- Cancel: Exit archive management interface and go on checking current patient;

5.15 Report

Press[ENTER]on the image to add the image into the report page. The report can be saved and printed. It is convenient for the doctor to view and edit the patients' information.

Reports contain normal report, abdominal report, cardiac report, small part report etc. Move the cursor to the required report page and press[ENTER] to choose.

Click the “Report” button and the page pop up the report page of the current exam mode. Change the other exam mode report by the drop-down box.



Report Interface

- ReportTitle: Report options, different kinds of report can choose, such as Normal, OB/GYN etc.
- Hosp: Display the hospital name.
- Abdomen Report: Display the kind of report.
- Patient Name: Display the patient name.
- Age: Display the patient age.
- Gender: Display the patient sex.
- Patient ID: Display the patient ID.
- Diagnostic: Input the diagnostic instructions.
- Description: Input the description of symptom.
- Tips: Input note information.
- Send DICOM SR: After activating DICOM , send DICOM structural report to server.
- Print: Print the report with image.

- Export: Export the PDF report to the U disk.
- Save: Save the report in system.
- The image on the right side: Press [ENTER] on the image to add the image into the report.

5.16 DICOM

5.16.1 DICOM Worklist

Press [Worklist] in Patient Interface , pop up the following dialog box

ID	Name	BirthDate	Sex	Doctor	Acc#

- ID:input ID or some characters , fuzzy query needs server
- Search By:select term , ID or name;
- ID:display the ID of patients
- Name:display the names of patients
- BirthDate:display the birthdate of patients
- Sex:display sex of patients
- Doctor:display names of doctors
- Acc#:display the NO. of patients
- Search:press this button to do search operation
- Apply:select the searched patient and press this button , input all patient information into the new patient interface
- Clear:clear all searched content.

5.16.2 DICOM Storage

Check the “save and send” in setting , then DICOM storage when saving cine and images . Press send button in archive or freeze interface. DICOM Send interface as follows:

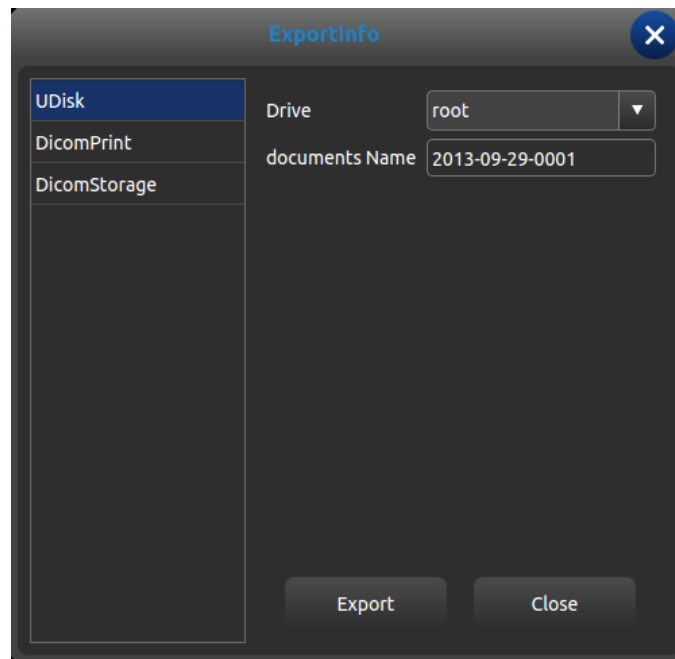

DICOM Send Interface

Select DICOMStorage in left , choose DICOM server and press Export button to DICOM storage.
Enter DIOCM Task Sequece and watch or edit DICOM process.

5.16.3 DICOM Print

DICOM Print operation is the same as DICOM storage

5.16.4 DICOM SR

Press Send DICOM SR button in report interface , this task is added into DICOM Tash Sequence.

Chapter 6 Measurement and Calculation

Main content of this chapter:

Normal calculation and measurement on B mode image and M mode image, OB calculation measurement etc, system can enter into corresponding measurement mode depend on current exam mode, and enter into the corresponding report depend on the measurement mode.

System has built-in the default measurement according to the exam mode, the change of measurement please refer to the chapter of preset settings.

6.1 Keyboard for Measurement

6.1.1 Trackball

Trackball is used to move the cursor, main functions are as follows:

- 1、 Before starting a measurement, use the trackball to choose the menu options;
- 2、 After starting a measurement, move the trackball to move the cursor, during the measurement, the cursor should not be moved out image area;
- 3、 During the Ellipse method measurement, use trackball to change the length of short axis.
- 4、 Update the moving of the measurement result, move the trackball to change the position of the measurement result.

6.1.2 [ENTER]

During the measurement, the functions of [ENTER]key are as follows:

- 1、 When cursor is on the menu, press the key to choose the options and start the measurement.
- 2、 During the measurement, press the key to anchor the start point and end point.

6.1.3 [UPDATE]

- 1、 Before the measurement, press[UPDATE]to change the measurement method, such as ellipse, trace. The changeable measurement item has “<>”.
- 2、 During the measurement, UPDATE-KEY is used to switch the start point and end point, long axis and short axis when the measurement is not finished.
- 3、 During the distance measurement, press the[ENTER]to fix the start point, when the end point is not fixed, press the UPDATE-KEY to switch the start point and end point.

4、During the Ellipse measurement, when fix the long axis, but the short axis is not fixed, press the UPDATE-KEY to switch the long axis and short one.

6.1.4 [DEL]

Main functions are as follows:

In frozen status, press the[DEL], delete all the measurement results, comments and traces.

6.1.5 [Change]

Press[Change]to switch other menu;

Press[Exit]to exit;

6.1.6 [Exit]

Press[Exit]to exit the measurement menu.

6.1.7 Parameters control button

Press the corresponding button to update the function and use the function.

6.2 B Mode general Measurement methods

The system B mode contains Distance, Ellipse, and Trace.

6.2.1 Distance

Measurement steps:

- 1: Press the [Calc] button to enter into measurement. Update the [distance] item in the menu or press the quick measure button [Dist], it will display a segment “+”icon.
- 2: Move the “+”icon by cursor to fit the one point of the line. Press [ENTER] key to fix the start point and the cursor can be moved to the next position.
- 3: Press [UPDATE] key can change the activated point, and fit the other point of the line.
- 4: Move the cursor to the end-point, press [ENTER] again to complete the measurement.
- 5: After the measurement, the result will display in the measurement results area.
- 6: Repeat the steps from 1 to 4 to start next “distance” measurement. Press [DEL] key to delete all the measurements.

Note:

Each group of measurement is limited, if the measurement results beyond, it will begin a new group of measurement automatically.

6.2.2 Ellipse

Measurement steps:

- 1: Press the **[Calc]** button to enter into measurement. Update the **[Ellipse]** item in the menu or press the quick measure button **[Ellipse]**, it will display a segment “+” icon.
- 2: Move the “+” icon by cursor, Press **[ENTER]** key to fix the point and the cursor can be moved to form a round.
- 3: Press **[UPDATE]** key can exchange the activated point and the fixed point.
- 4: Move the cursor to the end-point of the ellipse, press **[ENTER]** to fix the axis, at the same time, the next axis be updated, and can change the size of the axis by the cursor.
- 5: Now press **[UPDATE]** key can exit to the step 4.
- 6: After fixing the next axis, can press **[ENTER]** key to complete the measurement.
- 7: After the measurement, the result will display in the measurement results area.
- 8: Repeat the steps from 1 to 6 to start next “ellipse” measurement. Press **[DEL]** key to delete all the measurements.

Note:

Each group of measurement is limited, if the measurement results beyond, it will begin a new group of measurement automatically.

6.2.3 Trace

Measurement steps:

- 1: Press the **[Calc]** button to enter into measurement. Update the **[Trace]** item in the menu or press the quick measure button **[Trace]**, it will display a segment “+” icon.
- 2: Move the “+” icon by cursor, Press **[ENTER]** key to fix the point and the cursor can be moved to the next position.
- 3: Make the cursor tracing along the edge of required area, the traced line can be not closed..
- 4: Now press **[UPDATE]** key to cancel the tracing.
- 5: Press **[ENTER]** key again in the endpoint, the start point and end point of trace line will be closed by a straight line.
- 6: After the measurement, the result will display in the measurement results area.
- 7: Repeat the steps from 1 to 5 to start next “trace” measurement. Press **[DEL]** key to delete all the measurements.

Note:

Each group of measurement is limited, if the measurement results beyond, it will begin a new group of measurement automatically.

6.2.4 Histogram

Histogram is used to calculate the gray distribution of the ultrasound echo signals within a specified area. Use the rectangle, ellipse or trace method to draw along the desired measurement area. The result is shown in the form of histogram.

Histogram can be measured only on the frozen image.

◆ Measurement steps by rectangular method:

- ① Click **[FREEZE]** key to freeze the image.

- ② Press **[ENTER]** in **[Histogram]** menu to enter into measurement status.
- ③ Click **[ENTER]** to fix one apex of the rectangle.
- ④ Move the trace ball to change the cursor position and fix the diagonal point of the rectangle
- ⑤ Move the trace ball to change the cursor position, fix the diagonal point of the rectangle, and press **[ENTER]** again to confirm the measurement area. The result will display on the measurement result area..

◆ Measure the histogram by ellipse or trace method: The method is the same as that to measure y ellipse or trace method, press **[UPDATE]** to change the measurement between ellipse and trace.

The horizontal axis represents the gray scale of the image ranging from 0 to 255.

The vertical axis represents the distribution ratio of each gray scale. The value shown on the top of vertical axis represents the percentage of the maximally distributed gray in the whole gray distribution.

6.2.5 Cross-section Diagram

Cross-section Diagram is used to measure the gray distribution of the ultrasound signals in the vertical or horizontal direction on a certain profile (section).

This measurement is only available in the frozen mode.

Measurement steps:

- ① Click **[FREEZE]** key to freeze the image.
- ② Click **[Meas.]** key , and choose **[B NORMAL MEAS]**.
- ③ Draw a straight line at the measuring position. The method is the same as that to measure distance.
- ④ The calculated result of the profile will be displayed at the centre of the screen.

1-The horizontal (or vertical) axis represents the projection of the profile line on the horizontal direction.

2-The vertical (or horizontal) axis represents the gray distribution of the corresponding points on the profile line.

The range is 0 to 255.

6.3 Normal measurement and calculation in B mode

Click display **[B]**, **[B/B]** or **4B** to enter into B, B/B or 4B mode, then click **[Calc]** key to enter into measurement status. Or press **[Change]** to choose the normal measurement.

Meas. Menu	Submenu	Unit	Meas. Method/ Meas. Formula	Comment
	Distance	cm	Refer to distance Meas.	
	area/circle	Area cm ² Circle cm	Refer to Ellipse and trace meas.	Ellipse and trace. Press [UPDATE] to change.

Meas. Menu	Submenu	Unit	Meas. Method/ Meas. Formula	Comment
	Volume (1 straight line)	ml	Refer to distance Meas. Formula: $V = (\pi/6) \times D^3$	D means: Depth
	Volume (1 ellipse)	ml	Refer to ellipse meas. Formula: $V = (\pi/6) \times A \times B^2$	A: Long Axis B: Short Axis
	Volume (2 straight line)	ml	Refer to distance Meas. Formula: $V = (\pi/6) \times D1 \times D2^2$	D1: the longer distance D2: the shorter distance
	Volume (3 straight line)	ml	Refer to distance Meas. Formula: $V = (\pi/6) \times D1 \times D2 \times D3$	D1, D2, D3: Distance
	Volume (1 straight line 1 ellipse)	ml	Refer to distance and ellipse Meas. Formula: $V = (\pi/6) \times A \times B \times M$	A: Long Axis B: Short Axis M: Distance
Ratio	Ratio (distance)		Refer to distance Meas. Formula: $R = D1/D2$	D1: First Distance D2: Second Distance
	Ratio (area)		Refer to ellipse Meas. Formula: $R = A1/A2$	A1: First Area A2: Second Area
Angle		deg	Refer to distance Meas.	Angle Range: 0°~ 180°
Histogram			Refer to histogram	
Cross-section diagram			Refer to Cross-section	

6.4 Canine measurement and calculation

Choose canine exam mode. Press [Calc] to enter into canine measurement status in B, B/B, 4B mode. Or press [Change] to choose the canine measurement.

Meas. Menu	Submenu	Unit	Meas. Method/ Meas. Formula	Comment
GS		cm	Refer to distance Meas.	
CRL		cm	Refer to distance Meas.	
HC Diameter		cm	Refer to distance Meas.	
Body Length		cm	Refer to distance Meas.	
Volume		ml	Refer to distance Meas. Formula: $V = (\pi/6) \times L \times W \times H$	L: Length W: Width H: Height
Thyroid	Length Width Height	cm	Refer to distance Meas.	L: Thyroid Length W: Thyroid Width H: Thyroid Height
Bladder Volume		ml	Refer to distance Meas. Formula: $V = (\pi/6) \times L \times H \times W$	L: Bladder Length W: Bladder Width H: Bladder Height

6.5 Feline measurement and calculation

Choose feline exam mode. Press [**Calc**] to enter into feline measurement status in B, B/B, 4B mode. Or press [**Change**] to choose the feline measurement.

Meas. Menu	Submenu	Unit	Meas. Method/ Meas. Formula	Comment
GS		cm	Refer to distance Meas.	
CRL		cm	Refer to distance Meas.	
HC Diameter		cm	Refer to distance Meas.	
Body Length		cm	Refer to distance Meas.	
Volume		ml	Refer to distance Meas. Formula: $V = (\pi/6) \times L \times W \times H$	L: Length W: Width H: Height
Thyroid	Length Width Height	cm	Refer to distance Meas.	L: Thyroid Length W: Thyroid Width H: Thyroid Height
Bladder		ml	Refer to distance	L: Bladder Length

Meas. Menu	Submenu	Unit	Meas. Method/ Meas. Formula	Comment
Volume			Meas. Formula: $V = (\pi/6) \times L \times H \times W$	W: Bladder Width H: Bladder Height

6.6 Equine measurement

Choose equine exam mode. Press [Calc] to enter into equine measurement status in B, B/B, 4B mode. Or press [Change] to choose the equine measurement.

Meas. Menu	Submenu	Unit	Meas. Method/ Meas. Formula	Comment
GS		cm	Refer to distance Meas.	
Volume		ml	Refer to distance Meas. Formula: $V = (\pi/6) \times L \times W \times H$	L: Length W: Width H: Height
Thyroid	Length Width Height	cm	Refer to distance Meas.	L: Thyroid Length W: Thyroid Width H: Thyroid Height
Bladder Volume		ml	Refer to distance Meas. Formula: $V = (\pi/6) \times L \times H \times W$	L: Bladder Length W: Bladder Width H: Bladder Height

6.7 Bovine Measurement and Calculation

Choose Bovine exam mode. Press [Calc] to enter into bovine measurement status in B, B/B, 4B mode. Or press [Change] to choose the bovine measurement.

Meas. Menu	Submenu	Unit	Meas. Method/ Meas. Formula	Comment
BPD		cm	Refer to distance Meas.	
CRL		cm	Refer to distance Meas.	
Body Length		cm	Refer to distance Meas.	
Volume		ml	Refer to distance Meas. Formula: $V = (\pi/6) \times L \times W \times H$	L: Length W: Width H: Height
Thyroid	Length Width	cm	Refer to distance Meas.	L: Thyroid Length W: Thyroid Width

Meas. Menu	Submenu	Unit	Meas. Method/ Meas. Formula	Comment
	Height			H: Thyroid Height
Bladder Volume		ml	Refer to distance Meas. Formula: $V = (\pi/6) \times L \times H \times W$	L: Bladder Length W: Bladder Width H: Bladder Height

6.8 Ovine Measurement and Calculation

Choose ovine exam mode. Press [**Calc**] to enter into ovine measurement status in B, B/B, 4B mode. Or press [**Change**] to choose the ovine measurement.

Meas. Menu	Submenu	Unit	Meas. Method/ Meas. Formula	Comment
BPD		cm	Refer to distance Meas.	
CRL		cm	Refer to distance Meas.	
Body Length		cm	Refer to distance Meas.	
GS		cm	Refer to distance Meas.	
Volume		ml	Refer to distance Meas. Formula: $V = (\pi/6) \times L \times W \times H$	L: Length W: Width H: Height
Thyroid	Length Width Height	cm	Refer to distance Meas.	L: Thyroid Length W: Thyroid Width H: Thyroid Height
Bladder Volume		ml	Refer to distance Meas. Formula: $V = (\pi/6) \times L \times H \times W$	L: Bladder Length W: Bladder Width H: Bladder Height

6.9 Normal Measurement and Calculation in M, B/M mode

click [**M**] key to enter M or B/M mode, press [**Calc**] key to enter into M mode measurement status.

Or press [**M Measurement**] on the menu to enter into M mode measurement status.

6.9.1 Distance

Measurement steps:

- ①Select menu item-“Distance” to enter into measurement.
- ②Click on the M image area, it will display a blue dotted line with two horizontal short line. The blue dotted line represents the position need to be measured. The distance between the two short lines is the distance you want to measure. The yellow short line represents it's in active status. Click it and drag the short line to anywhere you want to put. .
- ③Click [UPDATE] button to active the two short lines in turns and dragon them to change the distance between them. The measurement result will be displayed on the result area.

6.9.2 Time

Measurement steps:

- ①Select menu item[Time] to enter into measurement.
- ②Click on the M image area, it will display two blue straight dotted line. The blue dotted line with one yellow short line on it represents it is in active status. The distance between the two straight lines stands for time you want to measure. You can drag the active straight line to anywhere you want to change the measured time.
- ③Click [UPDATE] button to active the two straight lines in turns and dragon them to change the distance between them. The measurement result will be displayed on the result area .

6.9.3 Heart rate

Heart rate is used to calculate the number of heart beats per minute from cardiac image.

Measurement steps:

- ①Choose[Heart rate]menu item to enter into measurement.
- ②The method is same as M Time measurement.
- ③After the above measurement, the calculated heart rate result is displayed in the measurement result area.
- ④Repeat the steps form1 to 3 to start next measurement.

6.9.4 Velocity

Measurement step:

- ①Choose[Velocity]menu item to enter into measurement.
- ②Select the start point of the measurement and click on the screen. The yellow “+” cursor is active. Drag the cursor to the peak systolic wave.
- ③Click on the Switch key to active another point. Drag the active point to the end diastolic wave.
- ④Repeat 1-3 to do another measurement.

Note: The maximum number of the measurement result on the image area is one. The second measurement result will cover the first one. The measurement result area will list all the measurement values.

6.10 General Measurement in M mode

At real-time status, click [B/M] key twice to enter M mode, click [Calc]key to enter into M mode cardiology measurement status.

Meas. Menu	Submenu	Unit	Meas. Method/ Meas. Formula	Comment
Distance		cm	Refer to M distance Meas.	
Time		s	Refer to M time Meas.	
Velocity		cm/s	Refer to M velocity Meas.	
HR	One Cycle	bpm	Refer to M time Meas.	
	Double Cycles	bpm	Refer to M time Meas.	

6.11 Canine Measurement in M Mode

The same with M mode general measurement.

6.12 Feline Measurement in M Mode

The same with M mode general measurement.

6.13 Equine Measurement in M Mode

The same with M mode general measurement.

6.14 Bovine Measurement in M Mode

The same with M mode general measurement.

6.15 Ovine Measurement in M Mode

The same with M mode general measurement.

Chapter 7 Preset

This chapter introduces the operation to make settings of the system through preset menu at preset mode.

Preset function is used to set up working environment and status, parameters of each examination mode. The setting will be stored in the memory of system and not be lost even after the system is switched off. When the system is switched on, it will work automatically with the status which is required by the operator.

In preset interface, all operation relies on moving trackball to required Function button position. Press [ENTER] button to start operation.

7.1 General setting

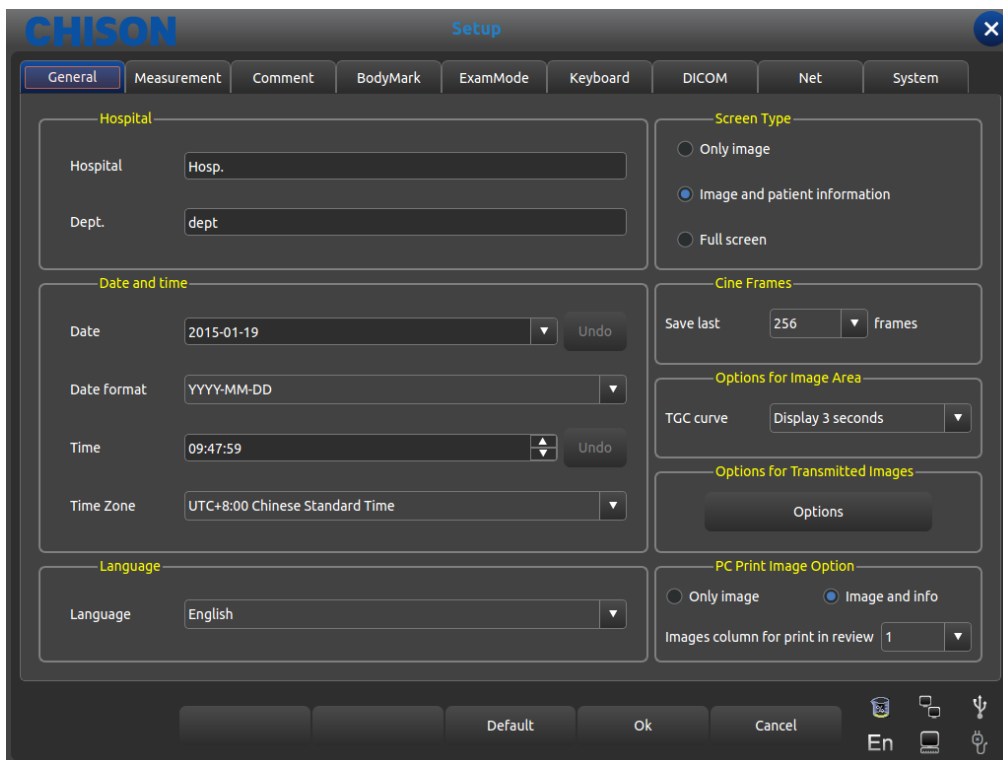

Press the [SETUP] key to enter system setting interface. User can do user-defined setting. Click [X] in the title bar or the exit key on the button can exit the system setting interface.

Form 1 General setting

Function name	Setting method	Function description
Hospital Department	Input freely	Set up the hospital name which is shown at top left corner of “General Setting” dialog box, 20 characters Max. can be input
Date and Time	Input freely	Set up the system date (calendar format), select current date directly. Date format can be changed by format

		setting.
Date Format	Set up freely	Set up date format: Year/Month/Date, Month/Date/Year, Date/Month/Year
Time zone	Set up freely	Set up the working clock of the system.
Language	Select language	Select the language of operation interface(Simplified Chinese English and so on)
Screen shot Type	Select the need type	Set the content which screen picture contain: only picture, image area and patient information, full screen
Frame number choice	Set up freely	Set the default frame when save the film
Options for image area	Click the button to open the setting box	Set the TGC curve, including always show, always hide and hide for 1 to 8 seconds.
Options for Transmitted Images	Click the button to open the setting box	Adjust the parameters of transmitted images: brightness, contrast, gamma.
Options for PC print image	Click the mode you need and open the setting box to choose the different parameter	Including print area and arrangement condition in the image foresee interface
default	Press button	Recover all preset to factory setting

7.2 Measurement

Measurement includes general measurement setting and measurement formula setting

7.2.1 General measurement setting

General settings can only change the display of measurement unit.

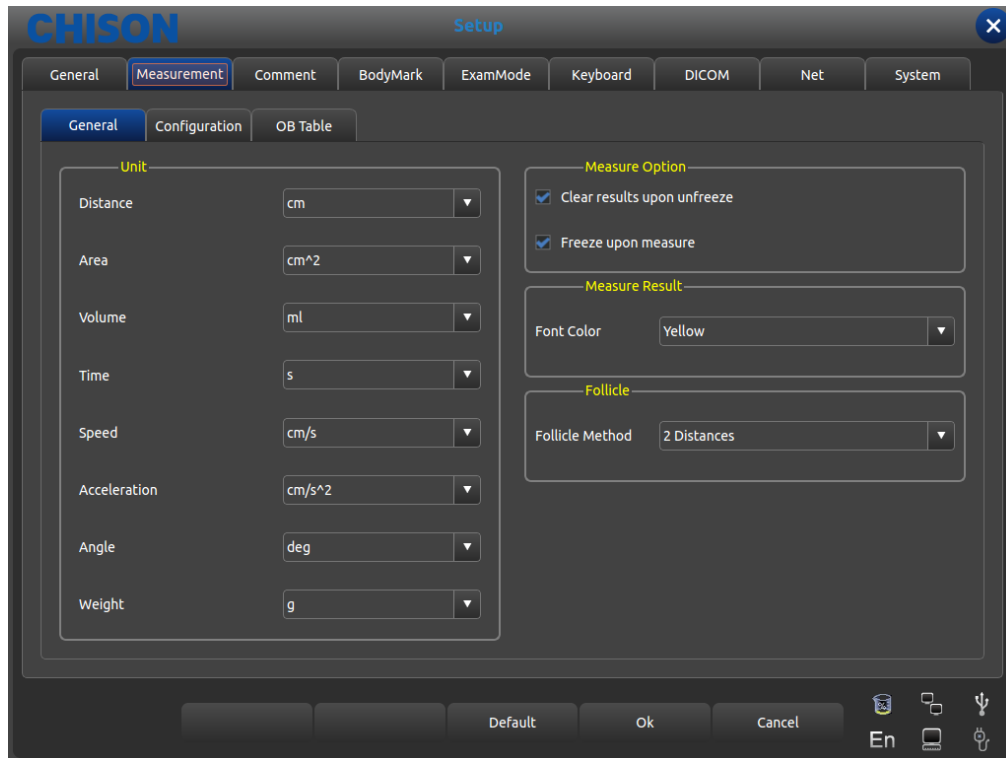

General Measurement settings interface

- Distance: cm, mm
- Area: cm^2 , mm^2
- Volume: ml, l
- Time: s, ms
- Speed: cm/s, mm/s
- Acceleration: cm/s^2 , mm/s^2
- Angle: deg, rad
- Weight: g, kg
- Measure Result Optional: whether clear results upon unfreeze, and the automatic froze image
- Measure Result: the color of the result font is alternative, including yellow/white/orange/green
- Follicle Method: ways to measure follicle, you can choose two distances and three distances.

7.2.2 Measurement formula setting

7.2.2.1 Interface Description-Measurement Menu

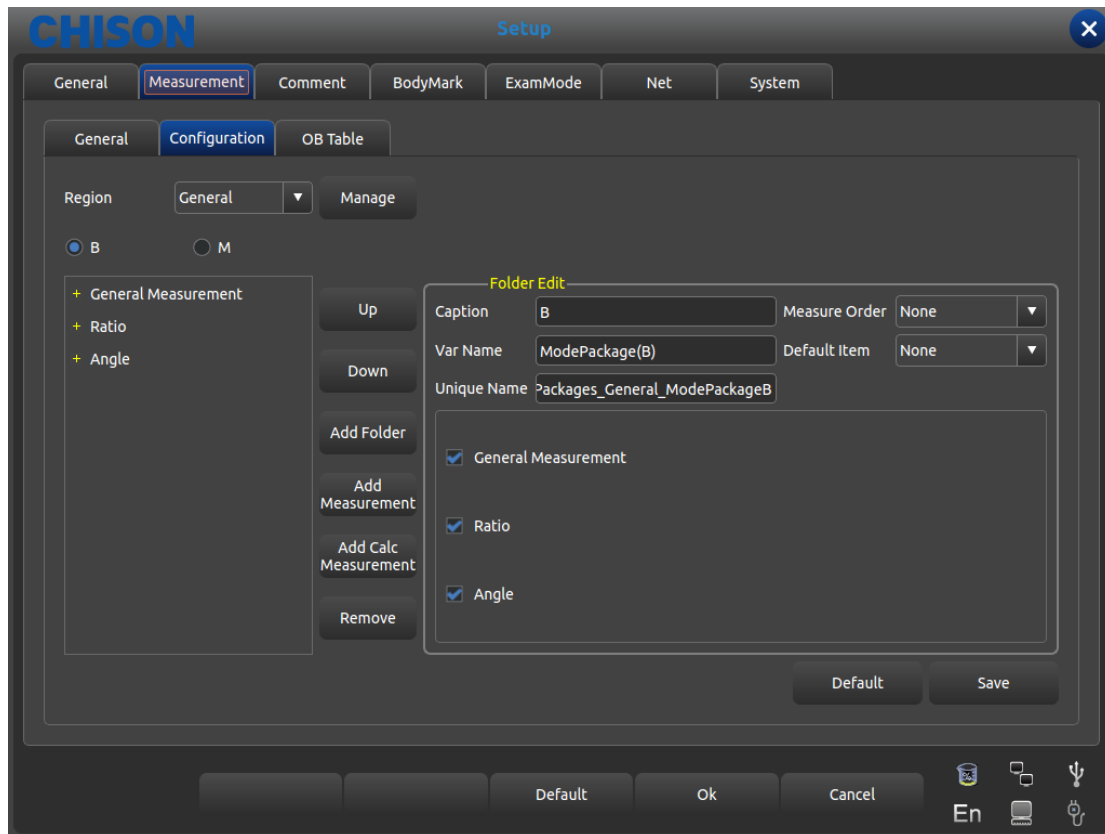

Interface for Edition of measurement Formula

- Region: pull down and select needed measurement menu
- Manage: pop up measurement software edition interface ,add modify delete change marshalling sequence in measurement menu.
- B、 M: display measurement of each Exam mode
- Up: press this button to move selected measurement term up
- Down: press this button to move selected measurement term down
- Add Folder: add a measurement item. In the left column when the term is fold there is “+” otherwise “-”
- Add Measurement: add a measurement item for a term in the right column there is selected item and detailed parameter.
- Add Calc Measurement: add a cal item for a measurement term
- Remove: remove selected measurement term or item.
- Default: restore all measurement term as factory setting.
- Save: save measurement item modification users did
- Check : display needed items on measurement menu, otherwise not displayed

Sheet 2 Folder Edit content description

Caption	Display names of all items that is displayed name in measurement menu
---------	---

Var Name	The name of built-in selected measurement menu, user don't need modify while display order according to the names
Unique Name	Built-in code, user don't need modify
Measurement rule	None: Disable rule , Repeat: Repeat this item , Sequential: measure by sequence
Default item	After choosing the Repeat and Sequential , choose one measurement or calculation to activate the measurement rule

7.2.2.2 Interface Description-Measurement Manipulation

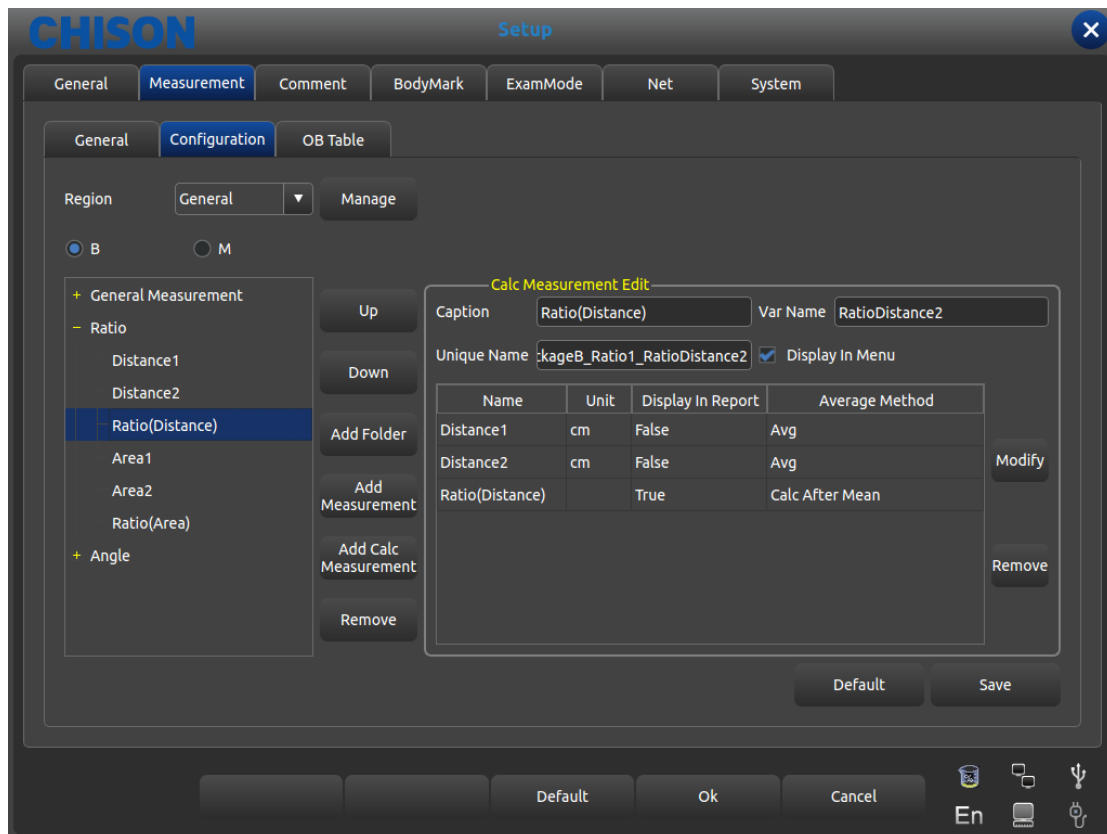

Interface for Edition of Measurement Formula
Sheet 3 Measurement Edit content description

Caption	Display the name of selected term that is display names in the measurement menu
Var Name	The name of built-in selected measurement menu, user don't need modify while display order according to the names
Unique Name	Built-in code, user don't need modify
Display In Menu	Check the required item and it will display on the measurement menu. The item without checking will not display on the measurement menu.
Choose measurement methods	Check the methods in measurement menu , press [update] to switch the method, Otherwise , the measurement is not available
Display in	Check and display the item in measurement menu ,

Report	otherwise ,the item is not displayed
Name	Measurement operation of specific measurement display in results
Unit	Data unit which measurement operation produces
Display In Report	Whether display in the report or not.
Average Method	The average rule of data
Modify	Press this button to pop up interface to modify measurement operation
Remove	Press this button to delete selected measurement operation

7.2.2.3 Interface Description-Measurement Calculation

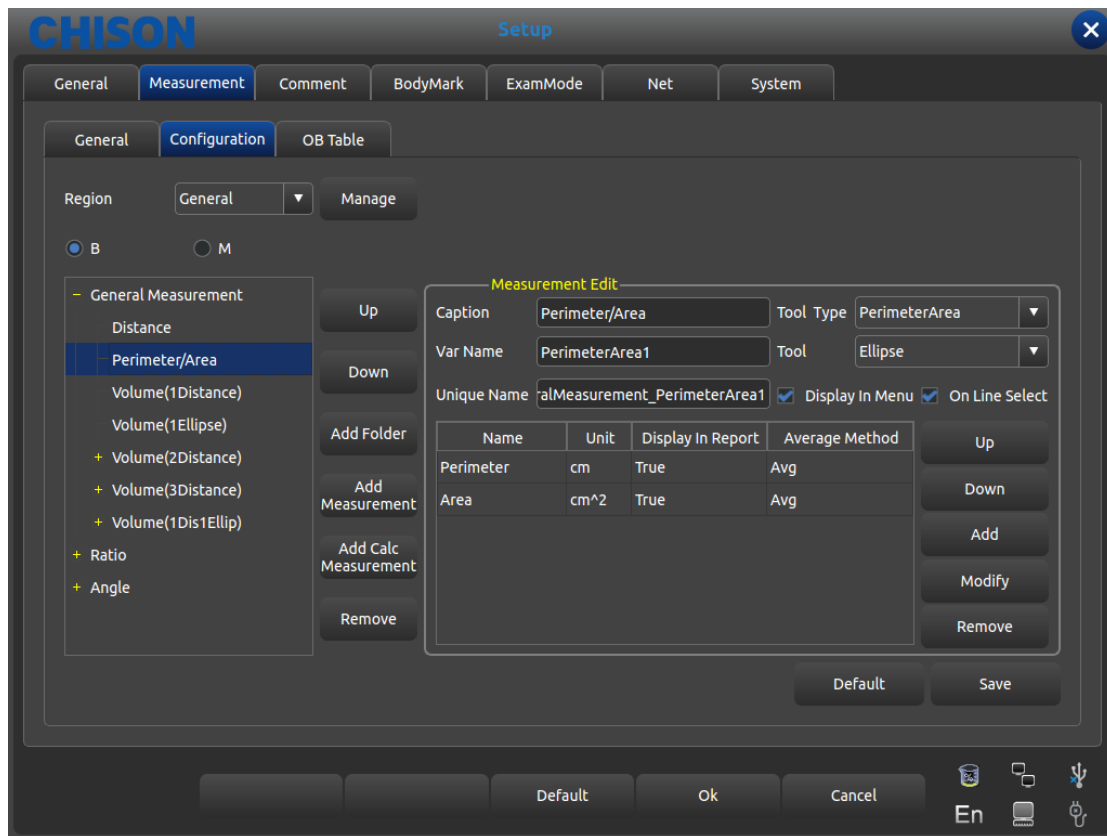

Interface for Edition of Measurement Formal

Sheet 4 Calc Measurement Edit content description

Caption	Display the name of selected term that is display names in the measurement menu
Var Name	The name of built-in selected measurement menu, user don't need modify while display order according to the names
Unique Name	Built-in code, user don't need modify
Tool Type/Tool	Select available measurement tool type B distance (B line),area/circumference(ellipse, trace),M distance(M vertical line),time(M horizontal line),M slope(M

		slant)
Display Menu	In	Check the required item and it will display on the measurement menu. The item without checking will not display on the measurement menu.
On Line Select		Press[UPDATE]to change the measurement method by checking it.
Name		Needed measurement operation of specific measurement and calculation
Unit		Data unit which measurement operation produces
Display Report	In	Whether display in the report or not.
Up		Press this button to move measurement operation up
Down		Press this button to move measurement operation down
Average Method		The average rule of data
Add		Press this button to pop up interface to add add measurement operation
Modify		Press this button to pop up interface to modify measurement operation
Remove		Press this button to delete selected measurement operation

7.2.2.4 Create Measurement Operation

Press [Add] in measurement operation interface, pop up the following dialog box

Interface for Edition of Measurement Formula

Sheet 5 Operation content description of creating new measurement

Caption	Display the name of selected term that is display names in the measurement menu
Var Name	The name of built-in selected measurement menu, user don't need modify while display order according to the names
Unique Name	Built-in code, user don't need modify
Ruler Result	Needed measurement operation of specific measurement and calculation
Edit	Enter into interface to edit formula when selecting calculation item
Maximum	The maximum value displays in result zone and report
Minimum	The minimum value displays in result zone and report
Unit	Data unit which measurement operation produces
Display In Report	Whether display in the report or not.
Method	The average rule of data

7.2.2.5 Formula Edit-Normal

It is necessary to enter into the following interface when creating measurement operation except OB

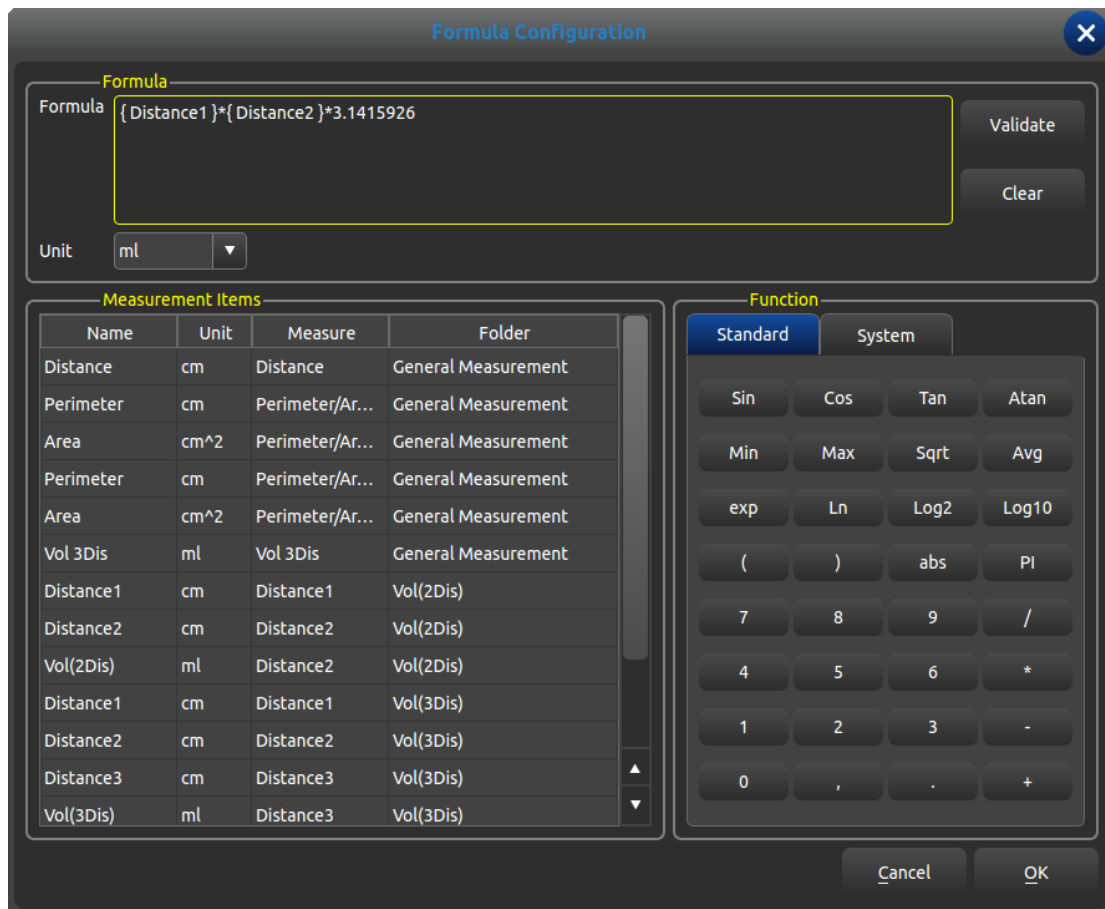

Interface for Edition of Measurement Formula

- Formula: edit formula in input box via keyboard and built-in formula.
- Validate: press this button to check whether the formula is right or not after editing formula.
- Clear: clear the content in the input box
- Unit: select the unit of calculation consequence
- Measurement Items: display all available measurement operation in the measurement menu.
- Function: built-in formula, number input and some parameters that system needs such as BSA, SPSA.etc
- Cancel: cancel editing formula and close the interface
- OK: save edited operation and close the interface

7.2.2.6 Formula Edit-OB

It is necessary to call built-in OB formula sheet when creating OB measurement operation the following function interface is required.

 Caution: the results of GA and EDD don't require unit, the unit of this class has been built-in.

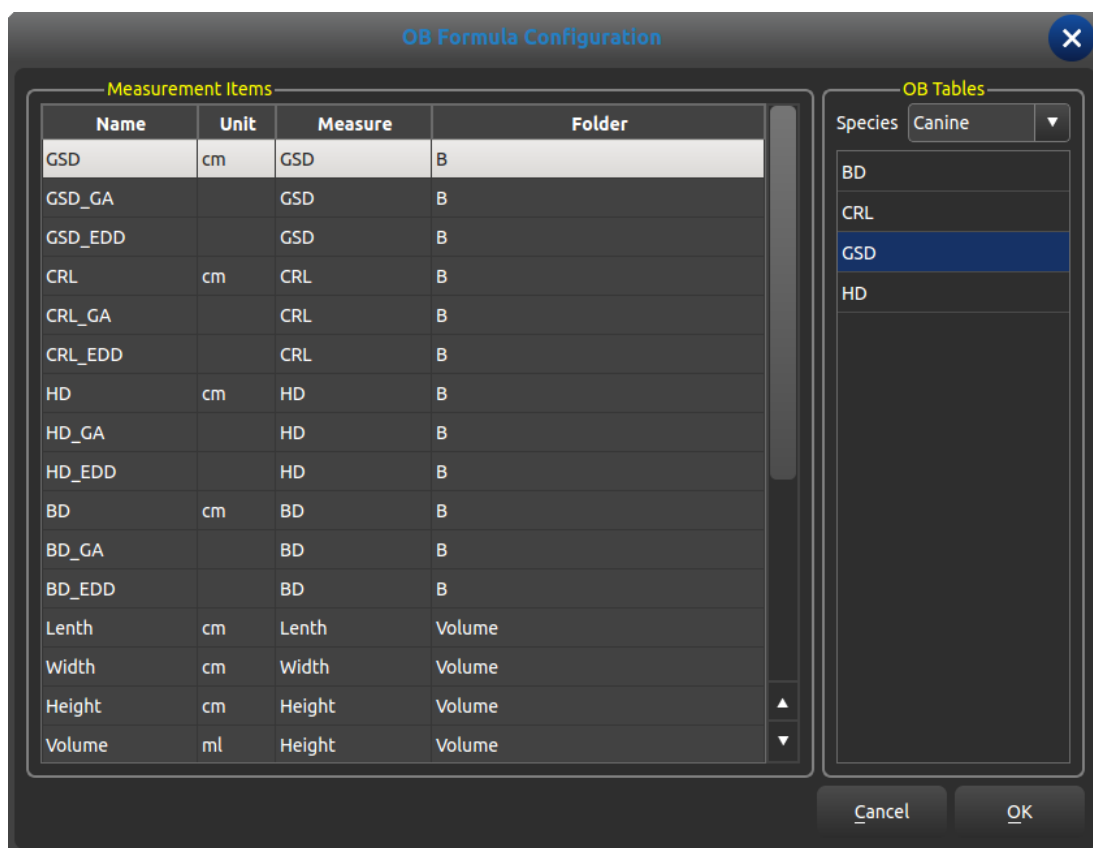

Measurement Items: display created measurement term by now

OB Tables: built-in OB formula table

OB List

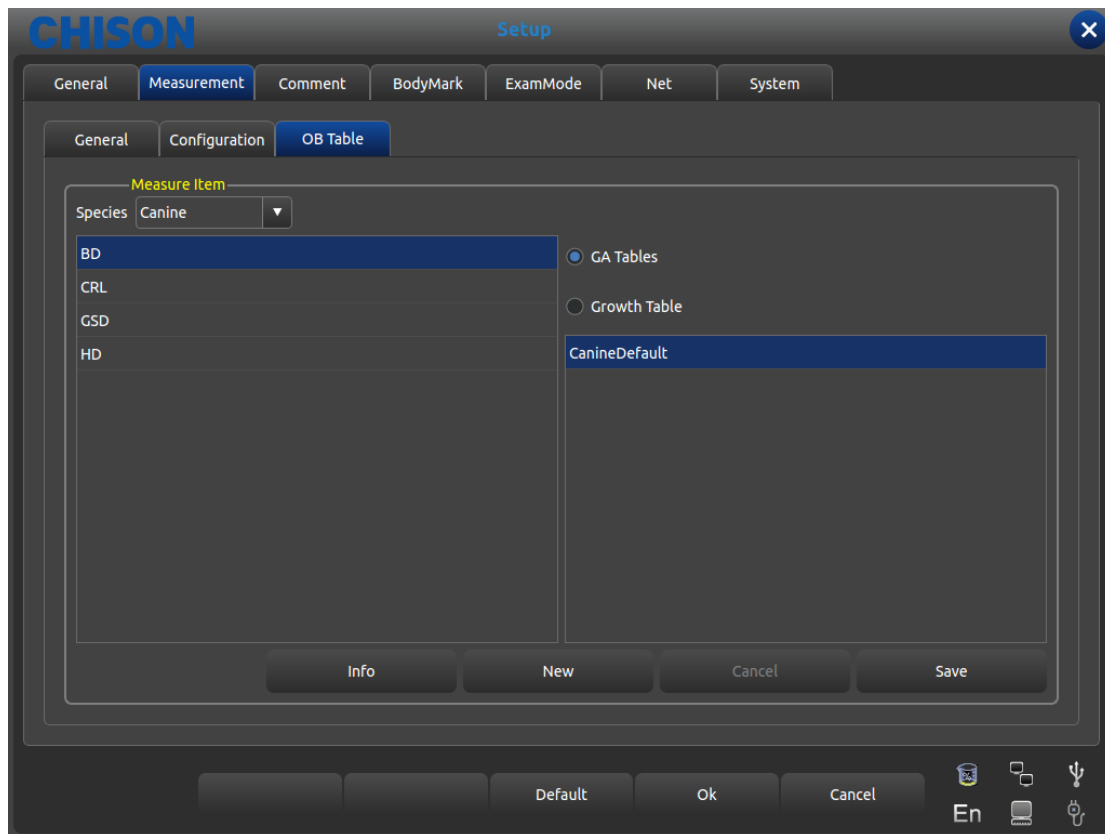

- Measure Item: OB Measurement Item
- GA Tables: Gestational list for the current measuring project.
- Growth Table: Growth table for the current measuring.
- Info: Display the gestational age and fetal weight for the current measuring.
- Cancel: Cancel the operation of choosing the formula
- Save: Save the users' choice of formulas

7.3 Annotation

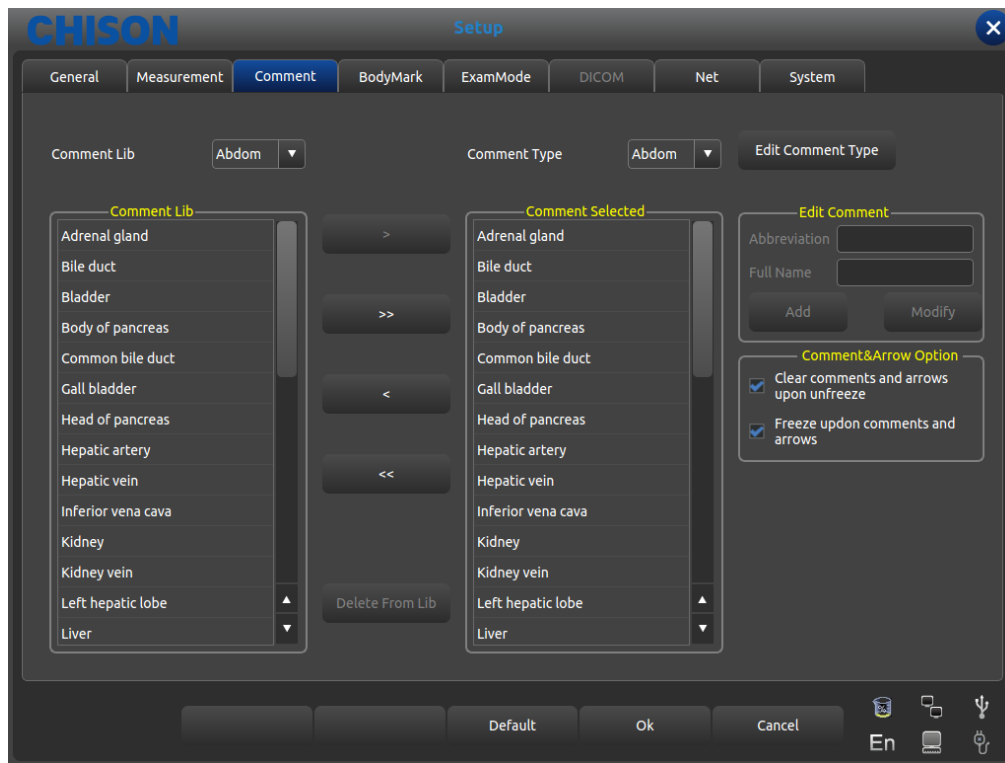

Annotation Setting Interface

7.3.1 Annotation Library

The annotation database of the system is classified as : abdomen、OB、GYN、Cardiac、small part、Pathological change Annotation can be made by inputting characters from the soft keyboard or recalling the terms saved in annotation database.

Press [**Comment Lib**] pull down button, pop up annotation name within system , through trackball and [**ENTER**] to show required annotation status.

7.3.1.1 Edit Annotation Library

Operation:

1. At the annotation status, Move the cursor to the [**Edit Comment Type**] button then press [**ENTER**] key, the annotation will be updated, and can be edited.
2. Input name into the new created annotation status box, Move the cursor to the [**Create**] button then press [**ENTER**] key, then create new annotation status and appear in selected annotation status list
3. Move the cursor to the [**Delete**] button, press [**ENTER**] key, then delete current annotation status in the selected annotation list.
4. Alter name of current annotation status list in [**Current Type Name**] input box, press [**ENTER**] on the [**Rename**] button, then rename the selected annotation status name.

7.3.2 Edit Annotation

Operator uses only current annotation instead of all content annotation status provides, inlay common annotation. If necessary, user can import annotation or self-compiled annotation into common annotation.

7.3.2.1 Add annotation from annotation library

Operation:

1. Select needed source annotation status via Trackball and **[ENTER]**
2. Select needed annotation at **[CommentLib]** column then press the **[ENTER]** button to activate this annotation.
3. Press **[ENTER]** on **[>]** button to import selected annotation into user-selected annotation status; press **[ENTER]** on **[>]** button to move selected annotation in **[Comment Selected]** column into source annotation.
4. Press **[ENTER]** on **[>>]** button to import all annotation in source into user-selected annotation status; press **[ENTER]** on **[>>]** button to move all annotation in **[Comment Selected]** column into source annotation.

7.3.2.2 Add annotation manually

Operation:

1. Activate **[Edit Comment]** input box via Trackball and **[ENTER]** button, then input needed abbreviation and full name of annotation.
2. Press **[ENTER]** on **[Add]** button, meanwhile this handout will be added into source and user-selected annotation status.

7.3.2.3 Alter annotation

Operation:

1. Alter annotation in user-selected status, the abbreviation and full name of annotation will be displayed in **[Edit Comment]** box.
2. Activate needed abbreviation and full name via **[ENTER]** and alter via keyboard.
3. Press **[ENTER]** on **[Modify]** button, modify the annotation in both source and user-selected status.

7.3.2.4 Delete annotation in library

Operation:

Select needed annotation in source status, press **[ENTER]** on **[Delete From Lib]** button then the annotation deleted.

7.3.3 Comment and Arrow Option

Optional: whether clear comments and arrows upon unfreeze.

Optional: whether freeze upon comments and arrows.

7.4 Body marks

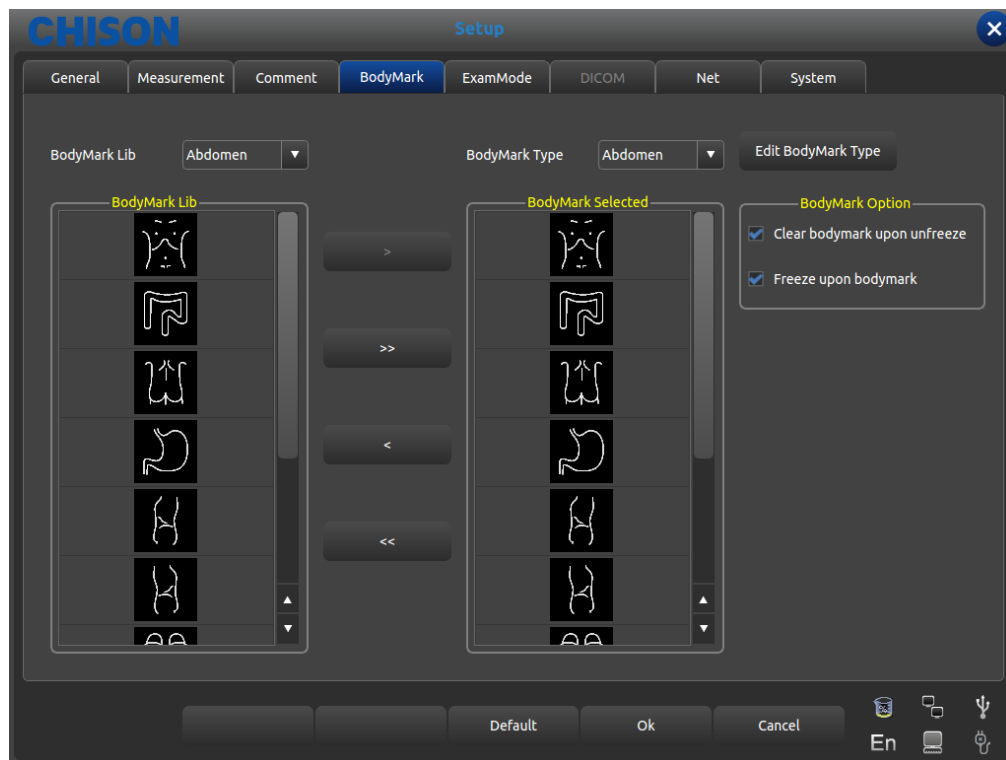

Interface for Body Mark Setting

7.4.1 Body Marks Library

Built-in body marks: Bovine, Canine, Equine, Feline and Ovine.

Press [**BodyMarkLib**] pull down button, pop up name of built-in body marks, show needed body marks via Trackball and [**ENTER**] button.

7.4.1.1 Edit body marks library

Operation:

1. Press [**ENTER**] on [**Edit BodyMark Type**], pop edit box.
2. Input name into the new created body marks box, Move the cursor to the [**Create**] button then press [**ENTER**] key, then the new body marks will be created and appear in selected body marks list
3. Move the cursor to the [**Delete**] button then press [**ENTER**] key, then delete current body marks in the selected list.
4. alter current annotation status list name in [**Current Type Name**] input box, press [**ENTER**] on the [**Rename**] button, then rename the selected body marks.

7.4.2 Body mark edition

Operation:

1. Select needed source body marks via Trackball and [ENTER]
2. Select needed body marks at [BodyMarkLib] column then press the [ENTER] button to activate it.
3. press [ENTER] on [>] button to import selected body marks into user-selected status; press [ENTER] on [>] button to move selected body marks in [BodyMark Selected] column into source body marks.
4. press [ENTER] on [>>] button to import all body marks in source into user-selected status; press [ENTER] on [>>] button to move all body marks in [BodyMarks Selected] column into source .

7.4.3 Body mark Option

Optional: whether clear bodymark upon unfreeze.

Optional: whether freeze upon bodymark.

7.5 Exam Mode

7.5.1 Exam Mode Edit

Press Utility in the submenu of [MENU], the parameters control area shows as following. According to the corresponding control button to turn on or off the function.

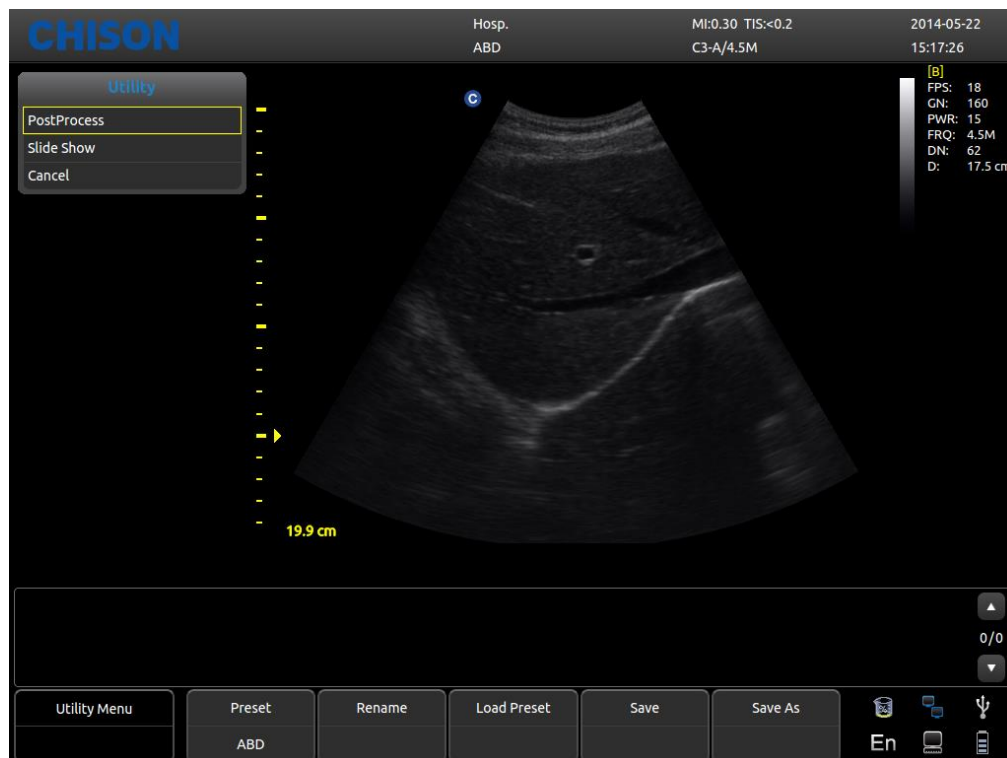

- Preset: Display the current preset.
- Rename: Rename the current preset.
- Load Preset: Load the preset displayed.
- Save: Save the current preset.
- Save As: Save the current preset as others.

7.5.2 Exam Mode Selection

Choose Utility and press [MENU],the following interface pop up. Open the relate function by corresponding control area.

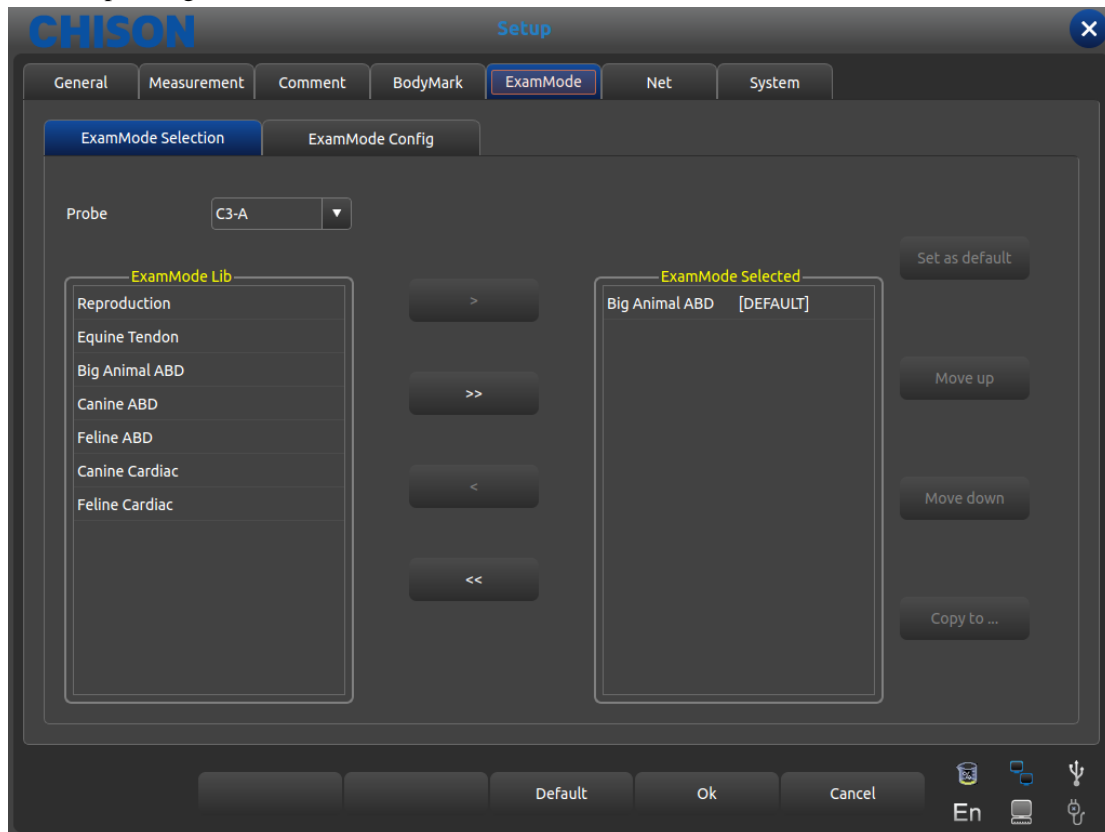

Interface for ExamMode Setting

- Probe: select needed probe and ExamMode fit for it.
- ExamModeLib: show all existed Exam modes.
- ExamMode Selected: show Exam modes in probe column.
- >: import selected Exam modes from ExamModeLib column to ExamMode Selected column.
- >>: import all Exam modes from ExamModeLib column into ExamMode Selected column.
- <: delete selected Exam modes in ExamMode Selected column.
- <<: delete all Exam modes in ExamMode Selected column.
- Set as default: set selected Exam modes in ExamMode Selected column as default
- Move up: move selected Exam modes in ExamMode Selected column up.
- Move down: move selected Exam modes ExamMode Selected column down.
- Copy to: copy the exam mode selected in ExamMode to a specified preset.

7.5.3 Exam mode selection

Operator can define needed Exam mode in detail including annotation, body marks, measurement menu import and export etc.

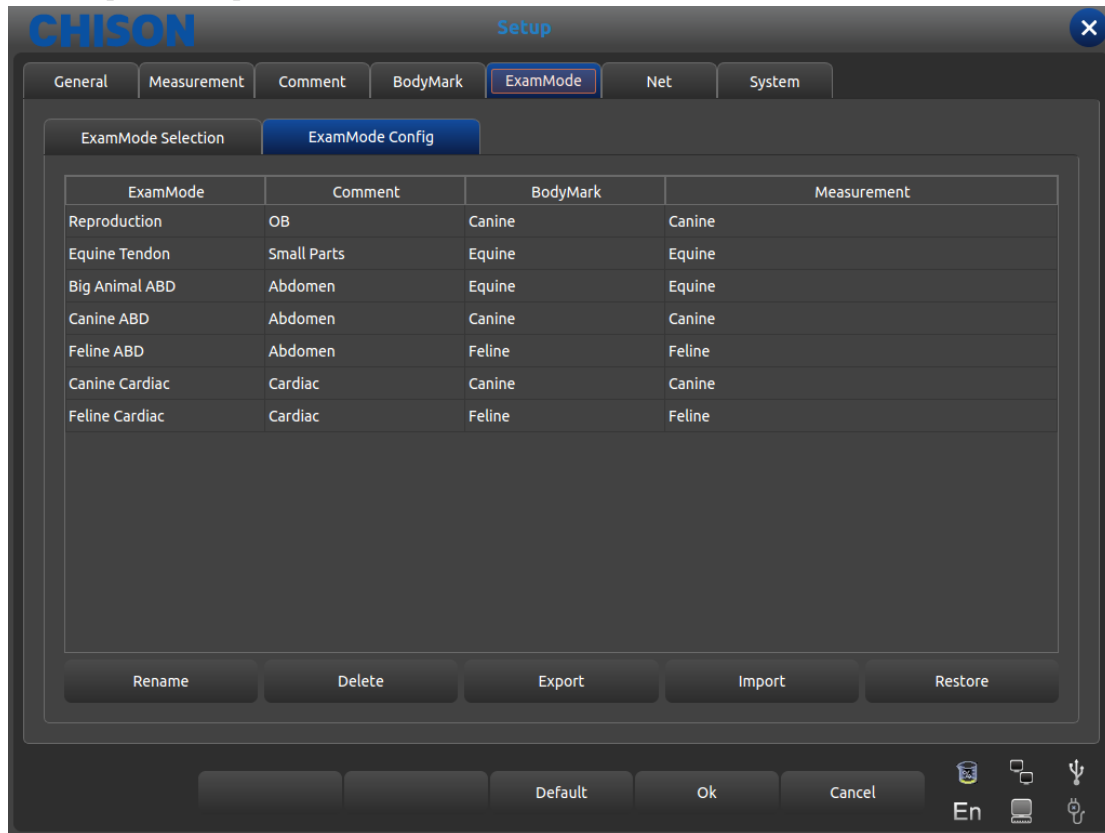

Interface for Exam Mode Setting

- ExamMode: show all existed Exam modes in system
- Comment: double click[ENTER]to activate widget box, can choose existed annotation status name. After setting, the default of the Exam mode is user-selected.
- BodyMark: same as Comment, select user-needed default body marks.
- Measurement: same as Comment, select user-needed default measurement menu.
- Rename: rename selected Exam mode
- Delete: delete selected Exam mode
- Export: export all built-in Exam modes into USB flash disk.
- Import: import all built-in Exam modes into USB flash disk.
- Restore: restore all Exam mode as factory setting.

7.6 Keyboard

Users can set the number buttons and the store button on the keyboard, easy to use.

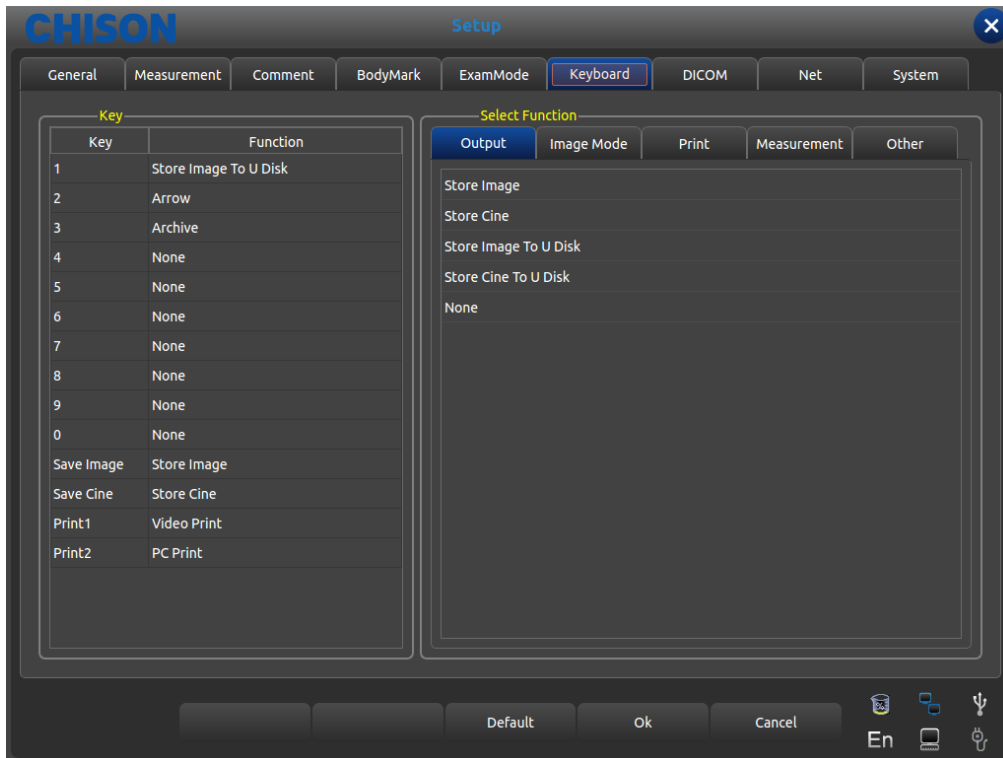

Interface for Keyboard Setting

- Output: including store images, store films, store images to U disk, store film to U disk, etc. function options.
- Image mode: including image full screen, biopsy, chroma, etc.
- Print: including video print, pc print etc.
- Others: including arrow, archive.

7.7 DICOM

DICOM includes DICOM Storage , DICOM Worklist , DICOM Print and DICOM SR . If DICOM is to be applied , please make sure DICOM has been activated . In the system page of setting interface , you can check whether DICOM is open or not . If you want to activate DICOM , please contact with Chison.

There must be DICOM SCP server which has been installed with PACS or other relative DICOM server software

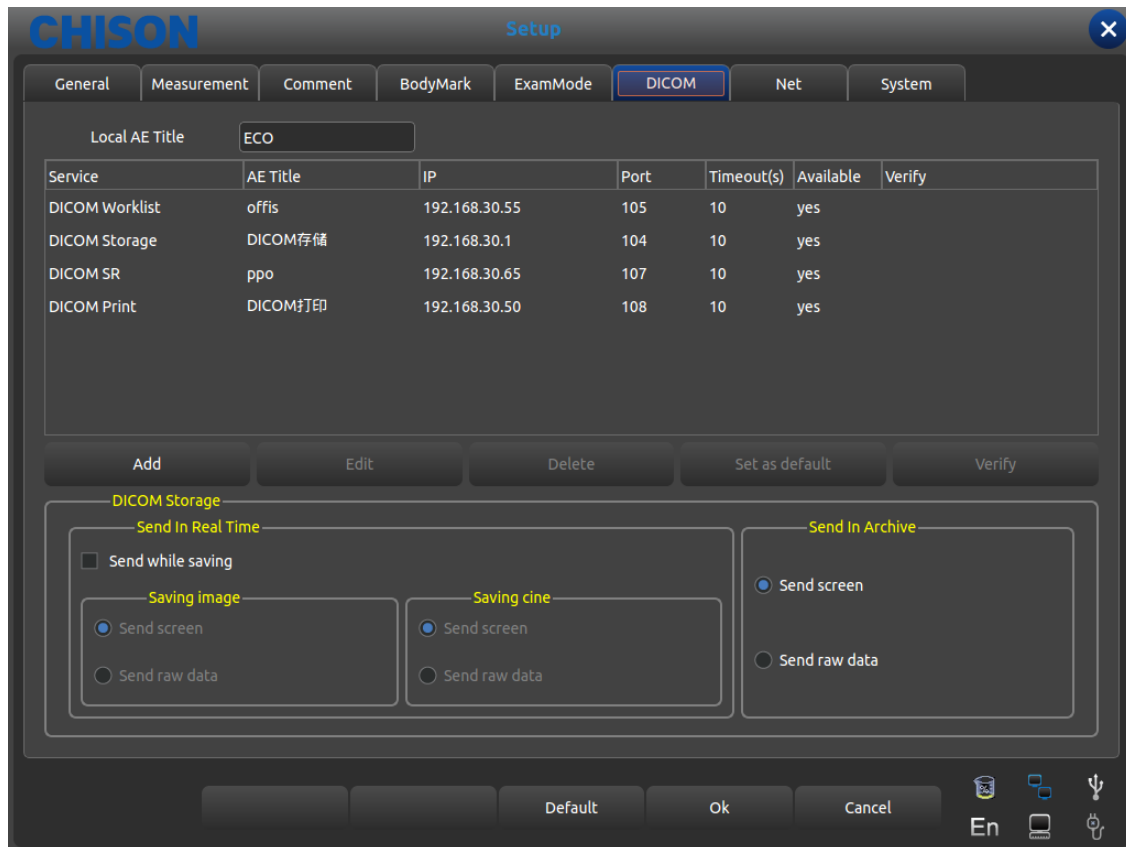

- Local AE Title:input local DICOM Title to separte the DICOM equipments in local network.
- Service:display the local DICOM function worklist ,
- AE Title: display the name of local DICOM AE title ,
- IP: display the IP of DICOM server,
- Port: display the port of DICOM server
- Timeout(s): display the delay tim
- Available: display whether DICOM is default or not ,
- Verify: Press verify button and display whether DICOM setting is correct or not
- Add: add DICOM function and pop up setting dialog,
- Delete: delete the existed DICOM function
- Set as default: set one DICOM service as default ,
- Send while saving: check this item and enable DICOM storage while saving image or cine , send clip or image according to activated function.
- Send in archive: send DICOM storage in archive or review , send clip or image according to activated function.

7.6.1 Add/Edit DICOM Function

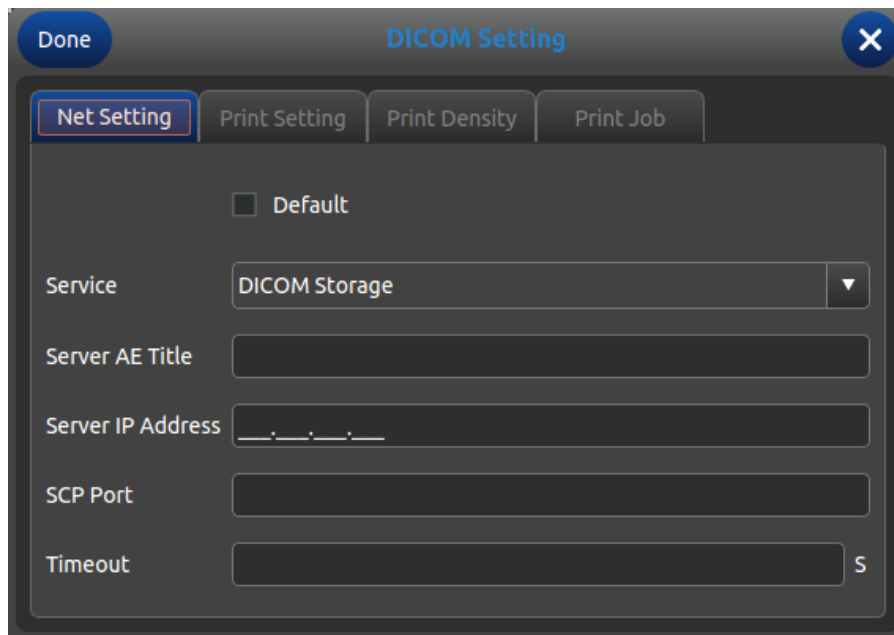

- Default: check this option , set DICOM function as default;
- Service: choose DICOM Storage , DICOM Worklist , DICOM Print or DICOM SR;
- Server AE Title: input DICOM server AE name;
- Server IP address: input DICOM IP address;
- SCP port: input DICOM server SCP port;
- Timeout: set the delay time of DICOM;
- Tip: choosing the DICOM Print type must be before relative print setting.

7.8 NET Work

Set the unit's and target unit's IP and do the connection testing.

7.9 System

7.9.1 System information

Display the software version, Hardware version, System version

7.9.2 Upgrade

Software and Hardware can be updated by USB flash drives.

Software upgrade File Path: X:\update\XXX or X:\update_SN\XXX.

Hardware update File Path: "X:\fpga_update\XXX",

Keyboard upgrade File Parth: "X:\ keyboard_update \XXX".

X means USB flash drives.XXX means upgrade content .It should restart manually after hardware update, and after software update, machine can be restarted automatically.

7.9.3 Function Setting

DICOM: Click [**Open**] key, it will bring up the DICOM Key Input dialog box. Input the DICOM SN, and click [**OK**]key to save and exit.

Full screen show: refer to DICOM.

7.9.4 Installment setting

Input relevant key to open trial function and the detail please contact CHISON Company.

7.9.5 Video VGA

Choose the video data: NTSC , PAL-M, PAL-D.

Video opened: Choose the item to open this function.

VGA opened: Choose the item to open this function.

7.9.6 Image function

Export hardware SN and import hardware secret key, it only for engineer use.

7.9.7 System Maintenance

Only an authorized service engineer may perform maintenance.

7.9.8 Digital Graphic Printer Option

Adjust the parameters of Video Printer Option: Dark, Light, Sharpness, Gamma.

Select the parameters needed to adjust, press [**Confirm**] button on the slider of the parameter, and move the trackball to change the parameter.

Chapter 8 System Maintenance

8.1 Machine Clean

 **Caution:** do turn off the power before cleaning and pull out the cable from socket. There is possibility of electric shock if the device is on

Clean methods:

Use the soft dry cloth to wrap the machine. If the device is quite dirty, use wet soft cloth. After wiping the blot, use soft dry cloth to wipe dry

 **Caution:**

1. Don't use organic solvent such as alcohol, otherwise surface may be ruined
2. When cleaning the machine, don't let the liquid inflow the machine, otherwise it may malfunction and there is danger of electric shock.
3. When it is necessary to clean the probe connector and peripheral instrument, please contact Sales office contact customer service or agent of Chison. Any self-cleaning may result in malfunction or degrading the function of device.

8.2 Probe Maintenance

The probes used by this machine can be divided into two series: body surface and intracavity. During all ultrasound scan, ultrasonic radiation on the human body should be as less as possible.

 **Caution:**

- Only person Received professional training can use the probes.
- Probes can't receive pressure sterilizer, when operation in sterile area, disposable sterile probe hood should be applied.
- Make sure not to drop the transducer on hard surface. This can damage the transducer elements and compromise the electrical safety of the transducer.
- Be careful when operation, make sure not to scratch the probe surface.
- Avoid kinking or pinching the transducer cable.
- Make sure not to connect the probe to plug or put adjacent cable into any kind of liquid.
- Keep the probe clean and dry. Power off or freeze when fixing or dismantling the probe.
- Make sure not to use or deposit the probe in the environment above 50 degree.
- If any abnormal phenomena of probe is found, immediately stop operation and contact with Sale Office, Customer Service department or Agents of manufacturer.

Cleaning

The cleaning procedure is fit for all probes. After operation every probe should do cleaning according to stated procedure of this passage. Inspection should be done for intracavity probe depends on condition of use

Cleaning procedure:

1. Wipe the remaining coupling gel and blot with flowing clear water. Avoid the joint part between cable and probe touching the water or others
2. Use wet gauze or other soft cloth with a little liquid soap to clean the probe totally. Don't use cleaning agent and cleaner with abrasiveness
3. Use flowing water to rinse fully. Use soft cloth which has been soaked by the concentration of 70% isopropyl alcohol to scrub. Then check the probe to make sure there is no blot.
4. Use clean cloth to dry the probe

 **caution:** Don't put the body surface probe into liquid below acoustical lens. Intracavity probe can't exceed insertion region. Prohibit putting connector of probe into any liquid.

Infection

Infection procedure is fit for intracavity probe

If it is necessary to use in surgery, please abide with instruction of professional infection person

infection procedure:

1. Obey the cleaning procedure to clean the probe totally
2. Prepare and retreat The concentration of 2% glutaraldehyde solution as the infection solution according to the instruction of manufacturer
3. Put the insertion region of probe into infection solution, the inserting depth can't exceed insertion region. Don't let the probe connector touch any liquid.
4. Soak the probe for 3 h
5. Pull out the probe, immediately rinse totally with sterile water and saline. To make sure of no any solution remaining. Please obey the rule to do right rinsing procedure including enough rinsing water and times
6. When probe is used in sterile area ,make sure to use disposable sterile probe hood

 **caution:**

- Don't soak probe connector into any liquid
- Don't let the soaking depth of intracavity probe exceed insertion region
- Prohibit soaking the probe in the liquid for more than 12 h
- Only use qualified inspection resolution

Deposit:

Please replace the probe in clean and dry environment, avoid direct sunshine

Keep the environment to deposit the probe during -10—50°C, Do not put it in high pressure and vacuum environment.

When accessing probe be careful and avoid ruin.

During transportation or leisure, the probe should be deposited in probe box.

8.3 Safety Check

To make sure this device works normally, a piece of maintenance plan is suggested to make to check the device regularly. If any abnormal phenomena, immediately stop operation and contact with Sale Office, Customer Service department or Agents of manufacturer.

If no image or menu but image, please check following malfunction table. If the malfunction can't be solved, please contact with Sale Office, Customer Service department or Agents of manufacturer.

8.4 Malfunction Check

serial number	malfunction	reason	Measures
1	Switch button lights but power LED not	Battery lose efficacy, Adapter works irregular	Check the connector between cable and power
2	Power Led lights but LED no image	The interval time is too short to restart	Restart after 1 minute
3	LED display character menu but no scan image	1. Launch power, gain or STC control errors 2. Not connect to probe or the probe connection is not correct 3. Device is in freezing condition	1. Control launch power, gain or STC control 2. Make sure of right connection 3. Exit from freezing condition
4	Abnormal image	1. Exam mode errors 2. Image processing setting errors	1. Whether Exam mode is proper or not 2. Adjust image processing setting or set it as default
5	Probe works improperly	1. The plug plugs loosely 2. Internal circuit protects	1. Extract the probe and reinsert 2. Restart
6	No OB calculation package menu	Do not select the OB application before scanning.	Select the OB application
7	PRINT-key doesn't work	1. The connected printer is approved 2. Printer power is not on 3. Printer is not connect well	1. Change the approved printer 2. Turn on the printer 3. Connect the printer again

Chapter 9 Probes

9.1 General Description

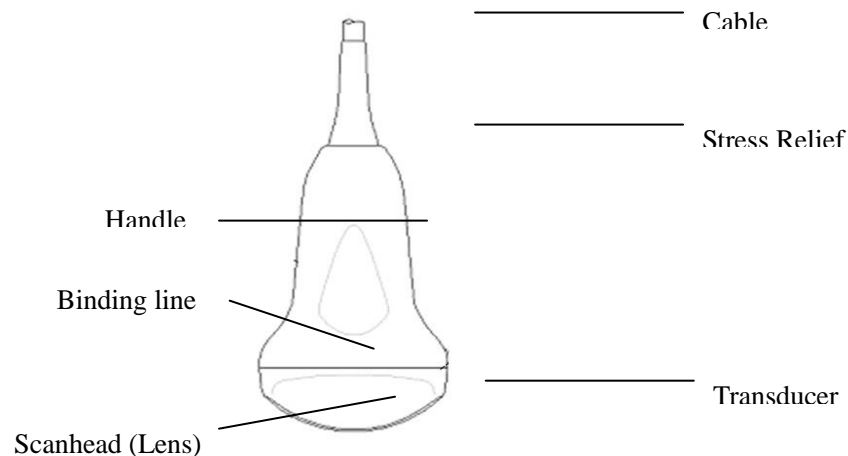

Convex Probe Overview

The probes provide high spatial and contrast ultrasound imaging of frequencies from 2.0MHz to 11.0MHz. These probes operate by pulsing sound waves into the body and listening to the returning echoes to produce high-resolution brightness mode, and a real time display.

9.2 Care and Maintenance

The probes that come with the system are designed to be durable and dependable. These precision instruments should be inspected daily and handled with care. Please observe the following precautions:

- Do not drop the transducer on hard surface. This can damage the transducer elements and compromise the electrical safety of the transducer.
- Avoid kinking or pinching the transducer cable.
- Use only approved ultrasonic coupling gels.
- Follow the instructions for cleaning and disinfecting that come with each probe.

9.2.1 Inspecting Probes

Before and after each use, inspect carefully the probe's lens, cable, casing, and connector. Look for any damage that would allow liquid to enter the probe. If any damage is suspected, do

not use the probe until it has been inspected and repaired/replaced by an authorized Service Representative.

⚠NOTE

Keep a log of all probe maintenance, along with a picture of any probe malfunction.

⚠WARNING

The probes are designed to be used only with this ultrasound system. Use of these probes on any other system or a non-qualified probe may cause electrical shock or damage on the system/transducer.

9.2.2 Cleaning and Disinfecting

- Place the probe into the solution of cleaning-disinfectant. Make sure not to immerse the probe into the liquid beyond the immersion level given in the pictures below. Make sure that the probe is covered with the cleaning-disinfectant up to the immersion level during the complete disinfection time.
- For the recommended cleaning and disinfection time, please see your Operating Manual .
- Scrub the probe as needed using a soft sponge, gauze, or cloth to remove all visible residue from the probe surface.
- Rinse the probe with enough clean, potable water to remove all disinfectant residues.
- Use a soft cloth to clean the cable and the user section of the probe with the cleaning disinfectant liquid. Make sure that the surface of the probe and cable is wetted thoroughly with the cleaning-disinfectant.
- Allow probe to air dry completely.
- Reconnect the probe to the ultrasound console and place the probe into it's holder.

Probe Immersion Levels

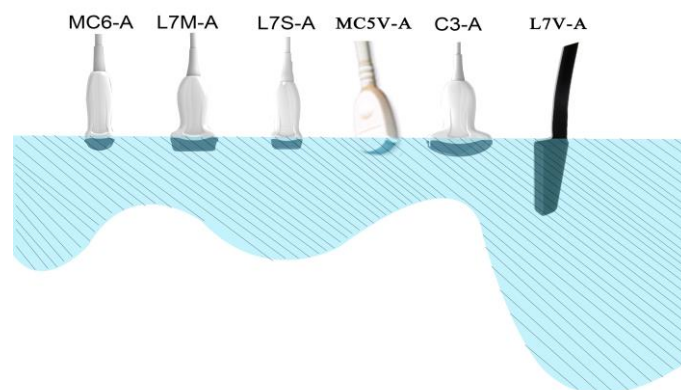

⚠CAUTION

These transducers are not designed to withstand heat sterilization methods. Exposure to temperatures in excess of 60 ° C will cause permanent damage. The transducers are not designed to be totally submerged in fluid, as permanent damage will result if the

entire transducer is submerged.

Probe Safety

Handling precautions

Ultrasound probes are highly sensitive medical instruments that can easily be damaged by improper handling. Use care when handling and protect from damage when not in use. DO NOT use a damaged or defective probe. Failure to follow these precautions can result in serious injury and equipment damage.

Electrical shock hazard:

The probe is driven with electrical energy that can injure the patient or user if live internal parts are contacted by conductive solution:

- DO NOT immerse the probe into any liquid beyond the level indicated by the immersion level diagram. Never immerse the probe connector into any liquid.
- Prior to each use, visually inspect the probe lens and case area for cracks, cuts, tears, and other signs of physical damage. DO NOT use a probe that appears to be damaged until you verify functional and safe performance. You need to perform a more thorough inspection, including the cable, strain relief, and connector, each time you clean the probe.
- Before inserting the connector into the probe port, inspect the probe connector pins. If a pin is bent, DO NOT use the probe until it has been inspected and repaired/replaced by a CHISON Service Representative.
- Electrical leakage checks should be performed on a routine basis by CHISON Service or qualified hospital personnel.

Mechanical hazard:

A defective probe or excess force can cause patient injury or probe damage:

- Observe depth markings and do not apply excessive force when inserting or manipulating endocavitary probe.
- Inspect probes for sharp edges or rough surfaces that may injure sensitive tissue.
- DO NOT apply excessive force to the probe connector when inserting into the probe port. The pin of a probe connector may bend.

Special handling instructions

Using protective sheaths

The use of market cleared probe sheaths is recommended for clinical applications. Reference FDA March 29, 1991 "Medical Alert on Latex Products".

Protective sheaths may be required to minimize disease transmission. Probe sheaths are available for use with all clinical situations where infection is a concern. Use of legally marketed, sterile probe sheaths is strongly recommended for endo-cavitary procedures.

DO NOT use pre-lubricated condoms as a sheath. In some cases, they can damage the probe. Lubricants in these condoms may not be compatible with probe construction.

Devices containing latex may cause severe allergic reaction in latex sensitive individuals. Refer to FDA's March 29, 1991 Medical Alert on latex products.

DO NOT use an expired probe sheath. Before using a sheath, verify if it has expired.

Endocavitary Probe Handling Precautions

If the sterilization solution comes out of the endocavitary probe, please follow the cautions below:

Sterilant Exposure to Patient (e.g., Cidex): Contact with a sterilant to the patient's skin for mucous membrane may cause an inflammation. If this happens, refer to instruction manual of the sterilant.

Sterilant Exposure from Probe handle to Patient (e.g. Cidex): DO NOT allow the sterilant to contact the patient. Only immerse the probe to its specified level. Ensure that no solution has entered the probe's handle before scanning the patient. If sterilant comes into contact with the patient, refer to the sterilant's instruction manual.

Sterilant Exposure from Probe connector to Patient (e.g. Cidex): DO NOT allow the sterilant to contact the patient. Only immerse the probe to its specified level. Ensure that no solution has entered the probe's connector before scanning the patient. If sterilant comes into contact with the patient, refer to the sterilant's instruction manual.

Endocavitary Probe Point of Contact: Refer to the sterilant's instruction manual.

Probe handling and infection control:

This information is intended to increase user awareness of the risks of disease transmission associated with using this equipment and provide guidance in making decisions directly affecting the safety of the patient as well as the equipment user.

Diagnostic ultrasound systems utilize ultrasound energy that must be coupled to the patient by direct physical contact.

Depending on the type of examination, this contact occurs with a variety of tissues ranging from intact skin in a routine exam to recirculating blood in a surgical procedure. The level of risk of infection varies greatly with the type of contact.

One of the most effective ways to prevent transmission between patients is with single use or disposable devices. However, ultrasound transducers are complex and expensive devices that must be reused between patients. It is very important, therefore, to minimize the risk of disease

transmission by using barriers and through proper processing between patients.

Risk of Infection

ALWAYS clean and disinfect the probe between patients to the level appropriate for the type of examination and use FDA-cleared probe sheaths where appropriate.

Adequate cleaning and disinfection are necessary to prevent disease transmission. It is the responsibility of the equipment user to verify and maintain the effectiveness of the infection control procedures in use. Always use sterile, legally marketed probe sheaths for intra-cavitary procedures.

Probe Cleaning process:

DO disconnect the probe from the system prior to cleaning/disinfecting the probe. Failure to do so could damage the system.

Perform Cleaning probe after each use

- Disconnect the probe from the ultrasound console and remove all coupling gel from the probe by wiping with a soft cloth and rinsing with flowing water.
- Wash the probe with mild soap in lukewarm water. Scrub the probe as needed using a soft sponge, gauze, or cloth to remove all visible residue from the probe surface. Prolonged soaking or scrubbing with a soft bristle brush (such as a toothbrush) may be necessary if material has dried onto the probe surface.

⚠ WARNING

To avoid electrical shock, always turn off the system and disconnect the probe before cleaning the probe.

⚠ CAUTION

Take extra care when handling the lens face of the Ultrasound transducer. The lens face is especially sensitive and can easily be damaged by rough handling. NEVER use excessive force when cleaning the lens face.

- Rinse the probe with enough clean potable water to remove all visible soap residue.
- Air dry or dry with a soft cloth.

⚠ CAUTION

To minimize the risk of infection from blood-borne pathogens, you must handle the probe and all disposables that have contacted blood, other potentially infectious materials, mucous membranes, and non-intact skin in accordance with infection control procedures. You must wear protective gloves when handling potentially

infectious material. Use a face shield and gown if there is a risk of splashing or splatter.

Disinfecting the probes:

After each use, please disinfect the probes. Ultrasound probes can be disinfected using liquid chemical germicides. The level of disinfection is directly related to the duration of contact with the germicide. Increased contact time produces a higher level of disinfection.

In order for liquid chemical germicides to be effective, all visible residue must be removed during the cleaning process. Thoroughly clean the probe, as described earlier before attempting disinfection.

You MUST disconnect the probe from the system prior to cleaning/disinfecting the probe. Failure to do so could damage the system.

DO NOT soak probes in liquid chemical germicide for longer than is stated by the germicide instructions for use. Extended soaking may cause probe damage and early failure of the enclosure, resulting in possible electric shock hazard.

- Prepare the germicide solution according to the manufacturer's instructions. Be sure to follow all precautions for storage, use and disposal. The transducer is not designed to be totally submerged in fluid. Permanent damage will result if the entire transducer is submerged. The immersed part shall not exceed the transducer binding line.
- Place the cleaned and dried probe in contact with the germicide for the time specified by the germicide manufacturer. High-level disinfection is recommended for surface probes and is required for endocavitary probes (follow the germicide manufacturer's recommended time).
- After removing from the germicide, rinse the probe following the germicide manufacturer's rinsing instructions. Flush all visible germicide residue from the probe and allow to air dry.
- Ultrasound transducers can easily be damaged by improper handling and by contact with certain chemicals. Failure to follow these precautions can result in serious injury and equipment damage
- Do not immerse the probe into any liquid beyond the level specified for that probe. Never immerse the transducer connector or probe adapters into any liquid.
- Avoid mechanical shock or impact to the transducer and do not apply excessive bending or pulling force to the cable.
- Transducer damage can result from contact with inappropriate coupling or cleaning agents:
- Do not soak or saturate transducers with solutions containing alcohol, bleach, ammonium chloride compounds or hydrogen peroxide
- Avoid contact with solutions or coupling gels containing mineral oil or lanolin
- Avoid temperatures above 60°C. Under no circumstances should the transducer be subjected to heat sterilization method. Exposure to temperatures above 60° C will cause permanent damage to the transducer.
- Inspect the probe prior to use for damage or degeneration to the housing, strain relief, lens and seal. Do not use a damaged or defective probe.

Coupling gels

DO NOT use unrecommended gels (lubricants). They may damage the probe and void the warranty. AQUASONIC Gel made by R. P. Kincheloe Company in USA is recommended.

In order to assure optimal transmission of energy between the patient and probe, a conductive gel must be applied liberally to the patient where scanning will be performed.

DO NOT apply gel to the eyes. If there is gel contact to the eye, flush eye thoroughly with water.

Coupling gels should not contain the following ingredients as they are known to cause probe damage:

- Methanol, ethanol, isopropanol, or any other alcohol-based product.
- Mineral oil
- Iodine
- Lotions
- Lanolin
- Aloe Vera
- Olive Oil
- Methyl or Ethyl Parabens (para hydroxybenzoic acid)
- Dimethylsilicone

Planned maintenance

The following maintenance plan is suggested for the system and probes to ensure optimum operation and safety.

Daily: inspect the probes

After each use: clean the probes, disinfect the probes.

As necessary: inspect the probes, clean the probes, disinfect the probes.

Returning/Shipping Probes and Repair Parts

Transportation dept. and our policy require that equipment returned for service MUST be clean and free of blood and other infectious substances.

When you return a probe or part for service, you need to clean and disinfect the probe or part prior to packing and shipping the equipment.

Ensure that you follow probe cleaning and disinfection instructions provided in this Manual.

This ensures that employees in the transportation industry as well as the people who receive the package are protected from any risk.

AIUM outlines cleaning the endocavitary transducer:

Guidelines for Cleaning and Preparing Endocavitary Ultrasound Transducers Between Patients From AIUM

Approved June 4, 2003

The purpose of this document is to provide guidance regarding the cleaning and disinfection of transvaginal and transrectal ultrasound probes.

All sterilization/disinfection represents a statistical reduction in the number of microbes present on a surface. Meticulous cleaning of the instrument is the essential icon to an initial reduction of the microbial/organic load by at least 99%. This cleaning is followed by a disinfecting procedure to ensure a high degree of protection from infectious disease transmission, even if a disposable barrier covers the instrument during use.

Medical instruments fall into different categories with respect to potential for infection transmission. The most critical level of instruments are those that are intended to penetrate skin or mucous membranes. These require sterilization. Less critical instruments (often called "semi-critical" instruments) that simply come into contact with mucous membranes such as fiber optic endoscopes require high-level disinfection rather than sterilization.

Although endocavitary ultrasound probes might be considered even less critical instruments because they are routinely protected by single use disposable probe covers, leakage rates of 0.9% - 2% for condoms and 8%-81% for commercial probe covers have been observed in recent studies. For maximum safety, one should therefore perform **high-level disinfection** of the probe between each use and use a probe cover or condom as an aid in keeping the probe clean.

There are four generally recognized categories of disinfection and sterilization. **Sterilization** is the complete elimination of all forms of microbial life including spores and viruses.

Disinfection, the selective removal of microbial life, is divided into three classes:

High-Level Disinfection - Destruction/removal of all microorganisms except bacterial spores.

Mid-Level Disinfection - Inactivation of Mycobacterium Tuberculosis, bacteria, most viruses, fungi, and some bacterial spores.

Low-Level Disinfection - Destruction of most bacteria, some viruses and some fungi. Low-level disinfection will not necessarily inactivate Mycobacterium Tuberculosis or bacterial spores.

The following specific recommendations are made for the use of Endocavitary ultrasound transducers. Users should also review the Centers for Disease Control and Prevention document on sterilization and disinfection of medical devices to be certain that their procedures conform to the

CDC principles for disinfection of patient care equipment.

1. CLEANING

After removal of the probe cover, use running water to remove any residual gel or debris from the probe. Use a damp gauze pad or other soft cloth and a small amount of mild non-abrasive liquid soap (household dishwashing liquid is ideal) to thoroughly cleanse the transducer. Consider the use of a small brush especially for crevices and areas of angulation depending on the design of your particular transducer. Rinse the transducer thoroughly with running water, and then dry the transducer with a soft cloth or paper towel.

2. DISINFECTION

Cleaning with a detergent/water solution as described above is important as the first step in proper disinfection since chemical disinfectants act more rapidly on clean surfaces. However, the additional use of a high level liquid disinfectant will ensure further statistical reduction in microbial load. Because of the potential disruption of the barrier sheath, additional high level disinfection with chemical agents is necessary. Examples of such high level disinfectants include but are not limited to:

- 2.4-3.2% glutaraldehyde products (a variety of available proprietary products including "Cidex," "Metricide," or "Procide").
- Non-glutaraldehyde agents including Cidex OPA (o-phthalaldehyde), Cidex PA (hydrogen peroxide & peroxyacetic acid).
- 7.5% Hydrogen Peroxide solution.
- Common household bleach (5.25% sodium hypochlorite) diluted to yield 500 parts per million chlorine (10 cc in one liter of tap water). This agent is effective, but generally not recommended by probe manufacturers because it can damage metal and plastic parts.

Other agents such as quaternary ammonium compounds are not considered high level disinfectants and should not be used. Isopropanol is not a high level disinfectant when used as a wipe and probe manufacturers generally do not recommend soaking probes in the liquid.

The FDA has published a list of approved sterilants and high level disinfectants for use in processing reusable medical and dental devices. That list can be consulted to find agents that may be useful for probe disinfection.

Practitioners should consult the labels of proprietary products for specific instructions. They should also consult instrument manufacturers regarding compatibility of these agents with probes. Many of the chemical disinfectants are potentially toxic and many require adequate precautions such as proper ventilation, personal protective devices (gloves, face/eye protection, etc.) and thorough rinsing before reuse of the probe.

3. PROBE COVERS

The transducer should be covered with a barrier. If the barriers used are condoms, these should be nonlubricated and nonmedicated. Practitioners should be aware that condoms have been shown to be less prone to leakage than commercial probe covers, and have a six-fold enhanced AQL (acceptable quality level) when compared to standard examination gloves. They have an AQL equal to that of surgical gloves. Users should be aware of latex-sensitivity issues and have available nonlatex-containing barriers.

4. ASEPTIC TECHNIQUE

For the protection of the patient and the health care worker, all endocavitary examinations should be performed with the operator properly gloved throughout the procedure. Gloves should be used to remove the condom or other barrier from the transducer and to wash the transducer as outlined above. As the barrier (condom) is removed, care should be taken not to contaminate the probe with secretions from the patient. At the completion of the procedure, hands should be thoroughly washed with soap and water.

 **Note:** *Obvious disruption in condom integrity does NOT require modification of this protocol. These guidelines take into account possible probe contamination due to a disruption in the barrier sheath.*

In summary, routine high-level disinfection of the endocavitary probe between patients, plus the use of a probe cover or condom during each examination is required to properly protect patients from infection during endocavitary examinations. For all chemical disinfectants, precautions must be taken to protect workers and patients from the toxicity of the disinfectant.

Amis S, Ruddy M, Kibbler CC, Economides DL, MacLean AB. Assessment of condoms as probe covers for transvaginal sonography. *J Clin Ultrasound* 2000;28:295-8.

Rooks VJ, Yancey MK, Elg SA, Brueske L. Comparison of probe sheaths for endovaginal sonography. *Obstet. Gynecol* 1996;87:27-9.

Milki AA, Fisch JD. Vaginal ultrasound probe cover leakage: implications for patient care. *Fertil Steril* 1998;69:409-11.

Hignett M, Claman P. High rates of perforation are found in endovaginal ultrasound probe covers before and after oocyte retrieval for in vitro fertilization-embryo transfer. *J Assist Reprod Genet* 1995;12:606-9.

Sterilization and Disinfection of Medical Devices: General Principles. Centers for Disease Control, Division of Healthcare Quality Promotion. <http://www.cdc.gov/ncidod/hip/sterile/sterilgp.htm>

(5-2003).

ODE Device Evaluation Information--FDA Cleared Sterilants and High Level Disinfectants with General Claims for Processing Reusable Medical and Dental Devices, March 2003. <http://www.fda.gov/cdrh/ode/germlab.html> (5-2003).

9.3 Probe Operation Instructions

For details on connecting, activating, deactivating, disconnecting, transporting and storing the probes.

9.3.1 Scanning the Patient

In order to assure optimal transmission of energy between the patient and probe, a conductive gel must be applied liberally to the patient where scanning will be performed.

After the examination is complete, follow the cleaning and disinfecting, or sterilizing procedures as appropriate.

9.4 Service Responsibility

If users install, use and maintain the system fully according to CHISON's installation manual, operation manual and service manual, then CHISON ECO main unit has a life time of 5 years and CHISON ECO probes have life time of 5 years after ex-work.

The warranty of the system and probes after ex-work is as the time in the warranty card.

The system is a precise electronic system. Only the CHISON's authorized service engineer could replace the defective parts. Any assembly, disassembly, handling, repair, or replacement by any other people may have adverse impact on the safety and effectiveness of the systems and probes, and thus will reduce the life time of the system and probes, and such systems and probes will not be covered by CHISON warranty after the above improper handling. Standard maintenance must be performed by CHISON's authorized service engineer during the life time of the product.



CAUTION: When the above life time is expired, the effectiveness and safety of system and probes maybe greatly affected, so it's NOT suggested to continue using the system and probes even the system and probes seem work properly. But if user still wants to continue using the system and probes, user should first contact CHISON service center at CHISON headquarter to arrange the necessary safety check and calibration by CHISON's authorized service engineer. If CHISON headquarter service center provides the calibration certificate for the related system or probe, then user could continue use the system or probes according to the calibration certificate. However, if CHISON headquarter service center concludes that the system or probe is no longer complied to the safety and effectiveness standard, then user should immediately stop using the system or probe. User understands that such check and calibration cost will be born by the user. Systems and probes keep on using after the life time may also be difficult to repair and maintain, so it's suggested to renew the product after the life time.

Appendix A: Acoustic Output Report Table

Acoustic Output Table

Transducer Model: C3-A

Operating Mode: B

Index Label			MI	TIS			TIB	TIC
				Scan	Non-scan		Non-scan	
					Aaprt ≤ 1cm ²	Aaprt > 1cm ²		
Global Maximum Index Value			0.459	0.09			#	
Associated Acoustic Parameter	Pra		Mpa	0.889				
	P		mW		2			#
	Min of [Pa(Zs), Ita.a(Zs)]		mW					
	Zs		cm					
	Zbp		cm					
	Zb		cm					
	Z at max.Ipi.a		cm	3.05				
	deq(Zb)		cm					
	fawf		MHz	3.76	3.848			#
	Dim of Aaprt	X	cm		2.088			#
Y		cm		1.1			#	
Other Information	td		µs	0.546				
	prr		Hz	2293.6				
	pr at max.Ipi		MPa	1.31				
	deq at max.Ipi		cm					
	Ipa.a at max.MI		W/cm ²	32.433				
Operating Control Conditions	Mode		B	B				#
	Focus		cm	4	2			#
	A Power		%	100	100			#

Acoustic Output Table

Transducer Model: C3-A

Operating Mode: THI-B

Index Label			MI	TIS			TIB	TIC	
				Scan	Non-scan		Non-scan		
					Aaprt ≤ 1cm ²	Aaprt > 1cm ²			
Global Maximum Index Value			0.317	0.094				#	
Associated Acoustic Parameter	Pra		Mpa	0.626					
	P		mW		20			#	
	Min of [Pa(Zs), Ita.a(Zs)]		mW						
	Zs		cm						
	Zbp		cm						
	Zb		cm						
	Z at max.Ipi.a		cm	3.5					
	deq(Zb)		cm						
	fawf		MHz	3.894	4.031				#
	Dim of Aaprt	X	cm		2.088				#
Y		cm		1.1				#	
Other Information	td		μs	1.227					
	pr		Hz	1938.					
	pr at max.Ipi		MPa	0.996					
	deq at max.Ipi		cm						
	Ipa.a at max.MI		W/cm ²	39.47					
Operating Control Conditions	Mode		THI-B	THI-B				#	
	Focus		cm	4	2			#	
	A Power		%	100	100			#	

Acoustic Output Table

Transducer Model: C3-AOperating Mode: M

Index Label			MI	TIS			TIB	TIC	
				Scan	Non-scan		Non-scan		
					Aaprt≤1cm ²	Aaprt > 1cm ²			
Global Maximum Index Value			0.353			0.181	0.247	#	
Associated Acoustic Parameter	Pra		Mpa	0.666					
	P		mW				20	#	
	Min of [Pa(Zs), Ita.a(Zs)]		mW				10.627		
	Zs		cm				3.05		
	Zbp		cm				2.56		
	Zb		cm					3.55	
	Z at max.Ipi.a		cm	2.85					
	deq(Zb)		cm					0.802	
	fawf		MHz	3.562			3.581	3.569	#
	Dim of Aaprt	X	cm				6.96	6.96	#
Y		cm				1.1	1.1	#	
Other Information	td		μs	0.54					
	prr		Hz	2293.6					
	pr at max.Ipi		MPa	0.946					
	deq at max.Ipi		cm					0.775	
	Ipa.a at max.MI		W/cm ²	14.419					
Operating Control Conditions	Mode			M		M	M	#	
	Focus		cm	5		11	6	#	
	A Power		%	100			100	100	#

Acoustic Output Table

Transducer Model: L7M-A

Operating Mode: B

Index Label			MI	TIS		TIB	TIC	
				Scan	Non-scan			Non-scan
					Aaprt ≤ 1cm ²	Aaprt > 1cm ²		
Global Maximum Index Value			0.787	0.017				
Associated Acoustic Parameter	Pra		Mpa	1.923				
	P		mW		2			
	Min of [Pa(Zs), Ita.a(Zs)]		mW					
	Zs		cm					
	Zbp		cm					
	Zb		cm					
	Z at max.Ipi.a		cm	1.9				
	deq(Zb)		cm					
	fawf		MHz	5.834	7.234			
	Dim of Aaprt	X	cm		1.224			
Y		cm		0.45				
Other Information	td		µs	0.196				
	prr		Hz	4717				
	pr at max.Ipi		MPa	2.826				
	deq at max.Ipi		cm					
	Ipa.a at max.MI		W/cm ²	223.653				
Operating Control Conditions	Mode							
	Focus		cm	2.5	0.5			
	A Power		%	100	100			

Acoustic Output Table

Transducer Model: L7M-A

Operating Mode: THI-B

Index Label			MI	TIS		TIB	TIC	
				Scan	Non-scan			Non-scan
					Aaprt ≤ 1cm ²	Aaprt > 1cm ²		
Global Maximum Index Value			0.54	0.03				
Associated Acoustic Parameter	Pra		Mpa	1.554				
	P		mW		2			
	Min of [Pa(Zs), Ita.a(Zs)]		mW					
	Zs		cm					
	Zbp		cm					
	Zb		cm					
	Z at max.Ipi.a		cm	1.5				
	deq(Zb)		cm					
	fawf		MHz	7.876	8.002			
	Dim of Aaprt	X	cm		0.768			
Y		cm		0.5				
Other Information	td		μs	0.613				
	prr		Hz	3424.7				
	pr at max.Ipi		MPa	2.323				
	deq at max.Ipi		cm					
	Ipa.a at max.MI		W/cm ²	75.234				
Operating Control Conditions	Mode							
	Focus		cm	2.5	0.5			
	A Power		%	100	100			

Acoustic Output Table

Transducer Model: L7M-A

Operating Mode: M

Index Label			MI	TIS			TIB	TIC
				Scan	Non-scan		Non-scan	
					Aaprt ≤ 1cm ²	Aaprt > 1cm ²		
Global Maximum Index Value			0.623		0.066		0.036	
Associated Acoustic Parameter	Pra		Mpa	1.534				
	P		mW			2		2
	Min of [Pa(Zs), Ita.a(Zs)]		mW					
	Zs		cm					
	Zbp		cm					
	Zb		cm					1.5
	Z at max.Ipi.a		cm	1.8				
	deq(Zb)		cm					0.545
	fawf		MHz	5.654		7.123		7.123
	Dim of Aaprt	X	cm			2.56		2.56
Y		cm			0.5		0.5	
Other Information	td		µs	0.168				
	prr		Hz	4717				
	pr at max.Ipi		MPa	2.254				
	deq at max.Ipi		cm					0.545
	Ipa.a at max.MI		W/cm ²	134.678				
Operating Control Conditions	Mode							
	Focus		cm	2.5		0.5		0.5
	A Power		%	100		100		100

Acoustic Output Table

Transducer Model: L7S-A

Operating Mode: B

Index Label			MI	TIS		TIB	TIC	
				Scan	Non-scan			Non-scan
					Aaprt≤1cm ²	Aaprt > 1cm ²		
Global Maximum Index Value			0.694	0.035				
Associated Acoustic Parameter	Pra		Mpa	1.929				
	P		mW		2			
	Min of [Pa(Zs), Ita.a(Zs)]		mW					
	Zs		cm					
	Zbp		cm					
	Zb		cm					
	Z at max.Ipi.a		cm	1.5				
	deq(Zb)		cm					
	fawf		MHz	7.717	9.424			
	Dim of Aaprt	X	cm		0.768			
Y		cm		0.5				
Other Information	td		μs	0.18				
	prr		Hz	4717				
	pr at max.Ipi		MPa	2.877				
	deq at max.Ipi		cm					
	Ipa.a at max.MI		W/cm ²	237.09				
Operating Control Conditions	Mode			B	B			
	Focus		cm	5.5	1.5			
	A Power		%	100	100			

Acoustic Output Table

Transducer Model: L7S-A

Operating Mode: THI-B

Index Label			MI	TIS		TIB	TIC	
				Scan	Non-scan			Non-scan
					Aaprt ≤ 1cm ²	Aaprt > 1cm ²		
Global Maximum Index Value			0.731	0.031				
Associated Acoustic Parameter	Pra		Mpa	2.063				
	P		mW		30			
	Min of [Pa(Zs), Ita.a(Zs)]		mW					
	Zs		cm					
	Zbp		cm					
	Zb		cm					
	Z at max.Ipi.a		cm	1.5				
	deq(Zb)		cm					
	fawf		MHz	7.976	8.218			
	Dim of Aaprt	X	cm		0.768			
Y		cm		0.5				
Other Information	td		µs	0.618				
	prr		Hz	3424.7				
	pr at max.Ipi		MPa	3.119				
	deq at max.Ipi		cm					
	Ipa.a at max.MI		W/cm ²	184.797				
Operating Control Conditions	Mode			THI-B	THI-B			
	Focus		cm	5.5	2.5			
	A Power		%	100	100			

Acoustic Output Table

Transducer Model: L7S-AOperating Mode: M

Index Label			MI	TIS			TIB	TIC
				Scan	Non-scan		Non-scan	
					Aaprt \leq 1cm ²	Aaprt > 1cm ²		
Global Maximum Index Value			0.745		0.077		0.229	
Associated Acoustic Parameter	Pra		Mpa	1.913				
	P		mW			2		2
	Min of [Pa(Zs), Ita.a(Zs)]		mW					
	Zs		cm					
	Zbp		cm					
	Zb		cm					1.55
	Z at max.Ipi.a		cm	1.5				
	deq(Zb)		cm					0.082
	fawf		MHz	6.599		8.035		6.599
	Dim of Aaprt	X	cm			2.56		2.56
Y		cm			0.5		0.5	
Other Information	td		μ s	0.179				
	prr		Hz	4717				
	pr at max.Ipi		MPa	2.723				
	deq at max.Ipi		cm					
	Ipa.a at max.MI		W/cm ²	221.385				
Operating Control Conditions	Mode		M	M				
	Focus		cm	6.5		0.5		6.5
	A Power		%	100		100		100

Acoustic Output Table

Transducer Model: MC6-A

Operating Mode: B

Index Label			MI	TIS		TIB	TIC	
				Scan	Non-scan			Non-scan
					Aaprt≤1cm ²	Aaprt > 1cm ²		
Global Maximum Index Value			0.444	0.133				
Associated Acoustic Parameter	Pra		Mpa	0.95				
	P		mW		2			
	Min of [Pa(Zs), Ita.a(Zs)]		mW					
	Zs		cm					
	Zbp		cm					
	Zb		cm					
	Z at max.Ipi.a		cm	3.25				
	deq(Zb)		cm					
	fawf		MHz	4.572	5.716			
	Dim of Aaprt	X	cm		0.72			
Y		cm		1.7				
Other Information	td		μs	0.212				
	prr		Hz	3246.8				
	pr at max.Ipi		MPa	1.588				
	deq at max.Ipi		cm					
	Ipa.a at max.MI		W/cm ²	50.017				
Operating Control Conditions	Mode		B	B				
	Focus		cm	4	0.5			
	A Power		%	100	100			

Acoustic Output Table

Transducer Model: MC6-A

Operating Mode: THI-B

Index Label			MI	TIS		TIB	TIC	
				Scan	Non-scan			Non-scan
					Aaprt ≤ 1cm ²	Aaprt > 1cm ²		
Global Maximum Index Value			0.449	0.149				
Associated Acoustic Parameter	Pra		Mpa	1.112				
	P		mW		2			
	Min of [Pa(Zs), Ita.a(Zs)]		mW					
	Zs		cm					
	Zbp		cm					
	Zb		cm					
	Z at max.Ipi.a		cm	2.8				
	deq(Zb)		cm					
	fawf		MHz	6.346	6.315			
	Dim of Aaprt	X	cm		0.72			
Y		cm		1.7				
Other Information	td		µs	0.762				
	prr		Hz	3424.7				
	pr at max.Ipi		MPa	2.046				
	deq at max.Ipi		cm					
	Ipa.a at max.MI		W/cm ²	38.125				
Operating Control Conditions	Mode			THI-B	THI-B			
	Focus		cm	4	0.5			
	A Power		%	100	100			

Acoustic Output Table

Transducer Model: MC6-A

Operating Mode: M

Index Label			MI	TIS			TIB	TIC
				Scan	Non-scan		Non-scan	
					Aaprt≤1cm ²	Aaprt > 1cm ²		
Global Maximum Index Value			0.446			0.122	0.108	
Associated Acoustic Parameter	Pra		Mpa	0.912				
	P		mW				2	
	Min of [Pa(Zs), Ita.a(Zs)]		mW				0.973	
	Zs		cm				2	
	Zbp		cm				1.87	
	Zb		cm					2.8
	Z at max.Ipi.a		cm	2.8				
	deq(Zb)		cm					0.182
	fawf		MHz	4.527			5.215	4.527
	Dim of Aaprt	X	cm				2.4	2.4
Y		cm				1.7	1.7	
Other Information	td		μs	0.213				
	prr		Hz	3246.8				
	pr at max.Ipi		MPa	1.4				
	deq at max.Ipi		cm					0.182
	Ipa.a at max.MI		W/cm ²	42.456				
Operating Control Conditions	Mode			M		M	M	
	Focus		cm	4		8	4	
	A Power		%	100		100	100	

Acoustic Output Table

Transducer Model: L7V-A

Operating Mode: B

Index Label			MI	TIS		TIB	TIC	
				Scan	Non-scan			Non-scan
					Aaprt ≤ 1cm ²	Aaprt > 1cm ²		
Global Maximum Index Value			0.536	0.18			#	
Associated Acoustic Parameter	Pra		Mpa	1.251				
	P		mW		2			#
	Min of [Pa(Zs), Ita.a(Zs)]		mW					
	Zs		cm					
	Zbp		cm					
	Zb		cm					
	Z at max.Ipi.a		cm	3.46				
	deq(Zb)		cm					
	fawf		MHz	5.441	7.496			#
	Dim of Aaprt	X	cm		1.4976			#
Y		cm		1			#	
Other Information	td		µs	0.208				
	prr		Hz	3846.2				
	pr at max.Ipi		MPa	2.399				
	deq at max.Ipi		cm					
	Ipa.a at max.MI		W/cm ²	63.356				
Operating Control Conditions	Mode		B	B			#	
	Focus		cm	4	0.5		#	
	A Power		%	100	100		#	

Acoustic Output Table

Transducer Model: L7V-A

Operating Mode: THI-B

Index Label			MI	TIS			TIB	TIC	
				Scan	Non-scan		Non-scan		
					Aaprt≤1cm ²	Aaprt > 1cm ²			
Global Maximum Index Value			0.316	0.189				#	
Associated Acoustic Parameter	Pra		Mpa	0.881					
	P		mW		6				#
	Min of [Pa(Zs), Ita.a(Zs)]		mW						
	Zs		cm						
	Zbp		cm						
	Zb		cm						
	Z at max.Ipi.a		cm	2.1					
	deq(Zb)		cm						
	fawf		MHz	7.793	8.077				#
	Dim of Aaprt	X	cm		1.498				#
Y		cm		1				#	
Other Information	td		μs	0.623					
	prr		Hz	10811					
	pr at max.Ipi		MPa	1.55					
	deq at max.Ipi		cm						
	Ipa.a at max.MI		W/cm ²	25.731					
Operating Control Conditions	Mode		B	B				#	
	Focus		cm	4	0.5			#	
	A Power		%	100	100			#	

Acoustic Output Table

Transducer Model: L7V-A

Operating Mode: M

Index Label			MI	TIS			TIB	TIC
				Scan	Non-scan		Non-scan	
					Aaprt≤1cm ²	Aaprt > 1cm ²		
Global Maximum Index Value			0.487			0.024	0.086	#
Associated Acoustic Parameter	Pra		Mpa	1.133				
	P		mW				2	#
	Min of [Pa(Zs), Ita.a(Zs)]		mW			0.72		
	Zs		cm			2.1		
	Zbp		cm			2.068		
	Zb		cm				3.2	
	Z at max.Ipi.a		cm	3.15				
	deq(Zb)		cm				0.165	
	fawf		MHz	5.409		7.041	5.409	#
	Dim of Aaprt	X	cm			4.992	4.992	#
Y		cm			1	1	#	
Other Information	td		μs	0.191				
	prr		Hz	3846.2				
	pr at max.Ipi		MPa	2.06				
	deq at max.Ipi		cm				0.157	
	Ipa.a at max.MI		W/cm ²	38.104				
Operating Control Conditions	Mode		M			M	M	#
	Focus		cm	4		0.5	4	#
	A Power		%	100		100	100	#

Acoustic Output Table

Transducer Model: MC5V-A Operating Mode: B

Index Label			MI	TIS			TIB	TIC
				Scan	Non-scan		Non-scan	
					Aaprt \leq 1cm ²	Aaprt $>$ 1cm ²		
Global Maximum Index Value			0.45	0.05			#	
Associated	Pra	Mpa	0.99					
Acoustic	P	mW		20			#	
Parameter	Min of [Pa(Zs), Ita.a(Zs)]		mW					
	Zs	cm						
	Zbp	cm						
	Zb	cm						
	Z at max.Ipi.a	cm	4.55					
	deq(Zb)	cm						
	fawf	MHz	4.92	4.9			#	
	Dim of	X	cm	2.09			#	
	Aaprt	Y	cm	1.1			#	
Other	td	μ s	0.29					
Information	prr	Hz	2283					
	pr at max.Ipi	MPa	1.55					
	deq at max.Ipi	cm						
	Ipa.a at max.MI	W/cm ²	31.78					
Operating	Mode		B	B			#	
Control	Focus	cm	6	3			#	
Conditions	A Power	%	100	100			#	

Acoustic Output Table

Transducer Model: MC5V-AOperating Mode: THI-B

Index Label			MI	TIS			TIB	TIC	
				Scan	Non-scan		Non-scan		
					Aaprt \leq 1cm ²	Aaprt $>$ 1cm ²			n
Global Maximum Index Value			1.05	0.08				#	
Associated	Pra	Mpa	2.15						
Acoustic	P	mW		12				#	
Parameter	Min of [Pa(Zs), Ita.a(Zs)]		mW						
	Zs		cm						
	Zbp		cm						
	Zb		cm						
	Z at max.Ipi.a		cm	1.85					
	deq(Zb)		cm						
	fawf		MHz	4.23	4.21				#
		Dim of	X	cm	2.09				#
Aaprt		Y	cm	1.1				#	
Other	td		μ s	0.51					
Information	pr		Hz	3846.2					
	pr at max.Ipi		MPa	2.93					
	deq at max.Ipi		cm						
	Ipa.a at max.MI		W/cm ²	185.52					
Operating	Mode		THI-B	THI-B				#	
Control	Focus		cm	3	6			#	
Conditions	A Power		%	100	100			#	

Acoustic Output Table

Transducer Model: MC5V-A **Operating Mode:** M

Index Label			MI	TIS			TIB	TIC
				Scan	Non-scan		Non-scan	
					Aaprt \leq 1cm ²	Aaprt $>$ 1cm ²		
Global Maximum Index Value			0.51			0.09	0.19	#
Associated	Pra	Mpa	1.05					
Acoustic	P	mW					20	#
Parameter	Min of [Pa(Zs), Ita.a(Zs)]		mW			6.29		
	Zs		cm			4.25		
	Zbp		cm					
	Zb		cm				2.6	
	Z at max.Ipi.a		cm	4.25				
	deq(Zb)		cm				1.94	
	fawf		MHz	4.25		4.25	4.16	#
	Dim of Aaprt	X	cm			6.96	6.96	#
		Y	cm			1.1	1.1	#
Other	td		μ s	0.33				
Information	pr		Hz	668.9				
	pr at max.Ipi		MPa	1.25				
	deq at max.Ipi		cm				1.94	
	Ipa.a at max.MI		W/cm ²	22.8				
Operating	Mode		B+M			B+M	B+M	#
Control	Focus		cm	6		6	3	#
Conditions	A Power		%	100		100	100	#

Appendix B: Guidance and Manufacturer's Declaration

1. Guidance and manufacturer's declaration – electromagnetic emissions		
The ECO 1/3 VET is intended for use in the electromagnetic environment specified below. The customer or the user of the ECO 1/3 VET should assure that it is used in such an environment.		
Emissions test	Compliance	Electromagnetic environment – guidance
RF emissions CISPR 11	Group 1	The ECO 1/3 VET uses RF energy only for its internal function. Therefore, its RF emissions are very low and are not likely to cause any interference in nearby electronic equipment.
RF emissions CISPR 11	Class A	The ECO 1/3 VET is suitable for use in all establishments, including domestic establishments and those directly connected to the public low-voltage power supply network that supplies buildings used for domestic purposes.
Harmonic emissions IEC 61000-3-2	Class A	
Voltage fluctuations/ flicker emissions IEC 61000-3-3	Complies	

2. Guidance and manufacturer's declaration – electromagnetic immunity			
The ECO 1/3 VET is intended for use in the electromagnetic environment the ECO 1/3 VET should assure that it is used in such an environment.			
Immunity test	IEC 60601 test level	Compliance level	Electromagnetic environment – guidance
Electrostatic discharge (ESD) IEC 61000-4-2	±6 kV contact ±8 kV air	±6 kV contact ±8 kV air	Floors should be wood, concrete or ceramic tile. If floors are covered with synthetic material, the relative humidity should be at least 30 %.
Electrical fast transient/burst IEC 61000-4-4	±2 kV for power supply lines ±1 kV for input/output lines	±2 kV for power supply lines ±1 kV for input/output lines	Mains power quality should be that of a typical commercial or hospital environment.

Surge IEC 61000-4-5	±1 kV line(s) to line(s) ±2 kV line(s) to earth	±1 kV line(s) to line(s) ±2 kV line(s) to earth	Mains power quality should be that of a typical commercial or hospital environment.
interruptions and voltage variations on power supply input lines IEC 61000-4-11	<5 % UT (>95 % dip in UT) for 0,5 cycle 40 % UT (60 % dip in UT) for 5 cycles 70 % UT (30 % dip in UT) for 25 cycles <5 % UT (>95 % dip in UT) for 5 sec	<5 % UT (>95 % dip in UT) for 0,5 cycle 40 % UT (60 % dip in UT) for 5 cycles 70 % UT (30 % dip in UT) for 25 cycles <5 % UT (>95 % dip in UT) for 5 sec	Mains power quality should be that of a typical commercial or hospital environment. If the user of the ECO 1/3 VET requires continued operation during power mains interruptions, it is recommended that the ECO 1/3 VET be powered from an uninterruptible power supply or a battery.
Power frequency frequency (50-60 Hz) magnetic field IEC 61000-4-8	3 A/m	3 A/m	Power frequency magnetic fields should be at levels characteristic of a typical location in a typical commercial or hospital environment.
NOTE UT is the a.c. mains voltage prior to application of the test level.			

3 Guidance and manufacturer's declaration – electromagnetic immunity

The ECO 1/3 VET is intended for use in the electromagnetic environment specified below. The customer or the user of the ECO 1/3 VET should assure that it is used in such an environment.

3.1. Immunity test	IEC 60601 test level	IEC 60601 test level	Electromagnetic environment – guidance
Conducted RF IEC 61000-4-6 Radiated RF IEC 61000-4-3	3 Vrms 150 kHz to 80 MHz 3 V/m 80 MHz to 2,5 GHz	3 Vrms 3 V/m	Portable and mobile RF communications equipment should be used no closer to any part of the ECO 1/3 VET, including cables, than the recommended separation distance calculated from the equation applicable to the frequency of the transmitter. Recommended separation distance

			$d = 1,2 \sqrt{P}$ $d = 1,2 \sqrt{P}$ 80 MHz to 800 MHz $d = 2,3 \sqrt{P}$ 800 MHz to 2,5 GHz where P is the maximum output power rating of the transmitter in watts (W) according to the transmitter manufacturer and d is the recommended separation distance in metres (m) Field strengths from fixed RF transmitters, as determined by an electromagnetic site survey, should be less than the compliance level in each frequency range. Interference may occur in the vicinity of equipment marked with the following symbol: 
--	--	--	---

NOTE 1 At 80 MHz and 800 MHz, the higher frequency range applies.
 NOTE 2 These guidelines may not apply in all situations. Electromagnetic propagation is affected by absorption and reflection from structures, objects and people.

a Field strengths from fixed transmitters, such as base stations for radio (cellular/cordless) telephones and land mobile radios, amateur radio, AM and FM radio broadcast and TV broadcast cannot be predicted theoretically with accuracy. To assess the electromagnetic environment due to fixed RF transmitters, an electromagnetic site survey should be considered. If the measured field strength in the location in which the ECO 1/3 VET is used exceeds the applicable RF compliance level above, the ECO 1/3 VET should be observed to verify normal operation. If abnormal performance is observed, additional measures may be necessary, such as reorienting or relocating the ECO 1/3 VET.
 b Over the frequency range 150 kHz to 80 MHz, field strengths should be less than 3 V/m.

Recommended separation distances between portable and mobile RF communications equipment and the ECO 1/3 VET			
The ECO 1/3 VET is intended for use in an electromagnetic environment in which radiated RF disturbances are controlled. The customer or the user of the ECO 1/3 VET can help prevent electromagnetic interference by maintaining a minimum distance between portable and mobile RF communications equipment (transmitters) and the ECO 1/3 VET as recommended below, according to the maximum output power of the communications equipment.			
Rated maximum output power of transmitter W	Separation distance according to frequency of transmitter m		
	150 kHz to 80 MHz $d = 1,2 \sqrt{P}$	80 MHz to 800 MHz $d = 1,2 \sqrt{P}$	800 MHz to 2,5 GHz $d = 2,3 \sqrt{P}$
0,01	0,12	0,12	0,23

0,1	0,38	0,38	0,73
1	1,2	1,2	2,3
10	3,8	3,8	7,3
100	12	12	23

For transmitters rated at a maximum output power not listed above, the recommended separation distance d in metres (m) can be estimated using the equation applicable to the frequency of the transmitter, where P is the maximum output power rating of the transmitter in watts (W) according to the transmitter manufacturer.

NOTE 1 At 80 MHz and 800 MHz, the separation distance for the higher frequency range applies.

NOTE 2 These guidelines may not apply in all situations. Electromagnetic propagation is affected by absorption and reflection from structures, objects and people.

Appendix C: Measurement Results Summary

C3-A, 3.5MHz Convex Array

Measurement	Unit	Useful Range	Accuracy
Axial Distance	mm	Full Screen (0~230mm)	<±5%
Lateral Distance	mm	Full Screen (0~230mm)	<±5%
Circumference: trace method,ellipse method	mm	Full Screen (0~230mm)	<±5%
Area: trace method,ellipse method	mm ²	Full Screen (0~230mm)	<±10%

L7S-A, 9.0MHz Linear Array

Axial Distance	mm	Full Screen (0~100mm)	<±5%
Lateral Distance	mm	Full Screen (0~100mm)	<±5%
Circumference: trace method,ellipse method	mm	Full Screen (0~100mm)	<±5%
Area: trace method,ellipse method	mm ²	Full Screen (0~100mm)	<±10%

MC6-A, 6.0MHz Convex Array

Measurement	Unit	Useful Range	Accuracy
Axial Distance	mm	Full Screen (0~100mm)	<±5%
Lateral Distance	mm	Full Screen (0~100mm)	<±5%
Circumference: trace method,ellipse method	mm	Full Screen (0~100mm)	<±5%
Area: trace method,ellipse method	mm ²	Full Screen (0~100mm)	<±10%

L7M-A, 7.5MHz Linear Array

Axial Distance	mm	Full Screen (0~100mm)	<±5%
Lateral Distance	mm	Full Screen (0~100mm)	<±5%
Circumference: trace method,ellipse method	mm	Full Screen (0~100mm)	<±5%
Area: trace method,ellipse method	mm ²	Full Screen (0~100mm)	<±10%

L7V-A, 7.5MHz Linear Array

Axial Distance	mm	Full Screen (0~100mm)	<±5%
Lateral Distance	mm	Full Screen (0~100mm)	<±5%
Circumference: trace method,ellipse method	mm	Full Screen (0~100mm)	<±5%
Area: trace method,ellipse method	mm ²	Full Screen (0~100mm)	<±10%

MC5V-A, 5.0MHz Convex Array

Measurement	Unit	Useful Range	Accuracy
Axial Distance	mm	Full Screen (0~230mm)	<±5%
Lateral Distance	mm	Full Screen (0~230mm)	<±5%
Circumference: trace method,ellipse method	mm	Full Screen (0~230mm)	<±5%
Area: trace method,ellipse method	mm ²	Full Screen (0~230mm)	<±10%

Appendix D: Display Accuracy and Acoustic Measurement Uncertainties

According to IEC60601-2-37 and NEMA UD-3 2004, the display accuracy and acoustic measurement uncertainties are summarized in the table below.

Display accuracy of MI is $\pm 20\%$, and TI is $\pm 40\%$ or < 0.1 , if MI, TI below 0.5.

Item	Measurement Uncertainty (Percentage, 95% Confidence Value)
Center Frequency	$\pm 15\%$
Acoustic Power	$\pm 30\%$
Acoustic Intensity	$\pm 30\%$
Peak Rarefactional Pressure	$\pm 15\%$

Appendix E: Transducer Maximum Surface Temperature

According to the requirements of the section 42.3 in the standard IEC 60601-2-37:2007, the transducer surface temperature has been tested in two kinds of conditions: the transducer suspended in still air or transducer contacting human-tissue mimicking material. The calculation of the expanded uncertainty is based on the ISO Guide tout ye Expression of uncertainty in measurement. Three transducer samples have been tested and the confidence coefficient is at 95%, the value of t.975 is 4.30.

The measurement data were obtained under the test conditions employed at CHISON.

Transducer model	Maximum surface temperature(°C)
C3-A	<41.0
L7M-A	<41.0
L7V-A	<41.0
MC6-A	<41.0
L7S-A	<41.0
MC5V-A	<41.0