

INSTRUCTIONS FOR OPERATION AND INSTALLATION

MIMLED 600 | MIMLED 1000

MINOR SURGICAL LIGHTS

VERSIONS: TROLLEY STAND | CEILING SUPPORT | WALL SUPPORT



MIMSAL



Congratulations on the purchase of your new MIMLED 600 | MIMLED 1000 Minor surgical light from MIMSAL TRADE S.L.

Our simple operating concept allows for intuitive handling using both the control panel on the housing and the detachable handle. The light weight design of the light head and choice of quality and support systems certified for the medical field with integrated power supply allows flexible use at your workplace.

The specially developed optical concept with innovative LED technology enables bright and homogeneous illumination of the work area while generating less heat than conventional halogen lights. This gives you low-reflection lighting with high illuminance and a high color rendering index across the entire light field.

We hope you enjoy your MIMLED!

Your team from:

MIMSAL

MIMSAL TRADE S.L.

C/ Mollet, 17

Polígono Industrial Palou Nord

08401 – Granollers (Barcelona) SPAIN

Tel. +34 930 139 860

mimsal@mimsal.com













www.mimsal.com

TABLE OF CONTENTS





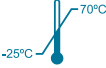
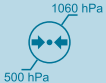

1. Safety Instructions	7
2. Brief Description	8
3. Operation	9
3.1 Check Before Each Use	9
3.2 Operation of the Lamp Head	9
3.2.1 Operation of Lamp Head	10
3.2.2 Quick Start via Sterilizable Handle	10
3.3 Working Areas of the Support Systems	11
3.3.1 Mobile Stand Model	11
3.3.2 Ceiling Mount Model	12
3.3.3 Wall Mount Model	13
4. Safety Functions	14
4.1 Protection Against Overheating	14
4.2 Undervoltage	14
4.3 Power Outage	14
4.4 Electrical Defect	14
5. Equipotential Bonding Conductor	15
6. Reprocessing of Sterile Accessories	16
6.1 Sterilizable Handle	16
6.2 Disinfection	16
6.3 Sterilization	17
6.4 Verification/Durability	17
6.5 Signs of Material Wear	17
7. Cleaning/Disinfection	18
7.1 General Safety Instructions	18
7.2 Cleaning	18
7.3 Disinfection	18
8. Maintenance	19
8.1 Support Systems	19
8.2 Lamp Head	20
9. Disposal	20

10. Mounting of the Lamp Head	21
10.1 Lamp Head Assembly	21
10.2 Mobile Stand Assembly	23
10.2.1 Mount Rollers	23
10.2.2 Mount Stand Tube	24
10.2.3 Mount Safety Ring	25
10.2.4 Mount Extension Arm with Spring Arm	28
10.2.5 Adjust Spring Force	30
10.2.6 Replacing Fuses	31
11. Mounting the Wall Fixture and Ceiling Fixture	32
11.1 Choice of Fasteners	33
11.2 Wall Mounting	33
11.3 Mounting the Ceiling Fixture	38
11.3.1 Mounting Ceiling Panel	38
11.3.2 Mounting Extension Arm with Spring Arm	39
11.3.3 Replacing the Fuse of the Ceiling Mount	41
11.4 Adjust Spring Force	42
11.5 Drilling Template	43
12. Data	44
12.1 Photometric Data for MIMLED	44
12.2 Electrical and Other Technical Data	45
12.3 Ambient Conditions	45
12.4 Physical Characteristics	46
12.5 Electromagnetic Compatibility	47
12.5.1 Immunity to High-Frequency Electromagnetic Fields in the Direct Vicinity of Wireless Communication Devices	49
12.6 Measures in the Event of Malfunctions or Changes in Performance	50
12.7 Inspection Plan for the Lamp Head	50

SYMBOLS

SYMBOL	MEANING
	INSTRUCTIONS
	DECLARATION OF CONFORMITY
	MEDICAL DEVICE
	ITEM CODE
	SERIAL NUMBER
	MANUFACTURING DATE
	NAME AND ADDRESS OF THE MANUFACTURER
	ELECTRONIC WASTE RECYCLING
	ELECTRICAL INSULATION CLASS Class I
	ELECTRICAL INSULATION CLASS Class II
	AMBIENT TEMPERATURE Shows the permitted ambient temperatures from -25 °C to 70 °C for transport and storage.
	AIR PRESSURE Shows the permitted air pressure values from 500 hPa to 1060 hPa for transport and storage.
	HUMIDITY Shows the permitted humidity values from 10% to 75% for transport and storage.

SAFETY RULES

SYMBOL	MEANING
	WARNING Non-observance may result in serious or even fatal injury.
	CAUTION Failure to do so may result in minor to moderate injury or damage.
	NOTE INFORMATION Gives application tips and useful information.
	FALLING OF THE LIGHT FIXTURE Warns of the sudden collapse of the support arm system due to the maximum payload being exceeded.
	SPRINGING OPEN OF THE SPRING ARM Warns of the sudden springing open of the spring arm when disassembling the end device.
	TIPPING HAZARD The support arm system, especially the mobile stand version, is only designed to support the weight of the light head. If additional weight is added, the unit may tip over, potentially hitting people and causing serious injury. Do not attach any other loads to or on the device.

MODEL AND REFERENCE

	REF	MODEL	SUPPORT
MIMLED 1000	ML1000C 200	MIMLED 1000 CEILING 200 mm	CEILING
	ML1000C 400	MIMLED 1000 CEILING 400 mm	CEILING
	ML1000C 600	MIMLED 1000 CEILING 600 mm	CEILING
	ML1000C 800	MIMLED 1000 CEILING 800 mm	CEILING
	ML1000C 1000	MIMLED 1000 CEILING 1000 mm	CEILING
	ML1000W	MIMLED 1000 WALL	WALL
	ML1000FL	MIMLED 1000 TROLLEY	TROLLEY STAND

	REF	MODEL	SUPPORT
MIMLED 600	ML600C 200	MIMLED 600 CEILING 200 mm	CEILING
	ML600C 400	MIMLED 600 CEILING 400 mm	CEILING
	ML600C 600	MIMLED 600 CEILING 600 mm	CEILING
	ML600C 800	MIMLED 600 CEILING 800 mm	CEILING
	ML600C 1000	MIMLED 600 CEILING 1000mm	CEILING
	ML600W	MIMLED 600 WALL	WALL
	ML600FL	MIMLED 600 TROLLEY	TROLLEY STAND

1. SAFETY INSTRUCTIONS



Please observe the operating instructions when handling the light!

The light is a class I medical device according to EU 2017/745.

Surroundings

1. This device is not intended for operation in potentially explosive areas!
2. Do not use in oxygen-enriched areas!
3. Do not use near flammable anesthetic gases!
4. Do not place near strong magnetic fields such as MRI systems!
5. Do not cover the top of the lamp head! Risk of overheating!
6. In operating rooms with displacement ventilation: Do not block the ventilation with the light!
7. In the operating room with displacement ventilation: Position the light at an angle to the flow!
8. Store the light in the packaging for at least 24 hours before mounting in the room to avoid droplet formation due to condensation!

Support arm system

1. Only use the supplied support arm system for lamp suspension!
2. The entire system must be completely disconnected from the mains supply before mounting!
3. Please observe the enclosed operating instructions!
4. The support arm system is intended exclusively for the suspension of the MIMLED. Do not attach or stack other units!

Electronic and optical safety

1. When using several lights, the total irradiance must be $< 1000 \text{ W/m}^2$!
2. Only connect the unit to the mains supply with the protective ground conductor connected!
3. Only use the integrated or enclosed power supply unit on the support arm system!
4. The light does not include a fail-safe power supply or an emergency battery!
5. In the event of a power failure, the light will be switched off completely!
6. Keep a backup unit ready in the operating rooms to ensure fail-safe operation!
7. Short interruptions in lighting are possible in the event of external EMC interference!
8. Only connect the device to a fused power supply (max. 20 A)!
9. To switch off the lamp completely, the mains plug must be removed from the socket or the live socket must be deactivated by a separate switch!

Maintenance and liability

1. Electrical, installation or maintenance work must be carried out by qualified personnel!
2. The manufacturer is not liable for damage caused by improper use!
3. The manufacturer is responsible for the safety of the lamp only if repairs and modifications are carried out by the manufacturer itself or by a company that guarantees compliance with the safety regulations, using original spare parts!

Before each use, make sure the lamp is in good condition.

2. BRIEF DESCRIPTION

TARGET GROUP

These operating instructions (including the operating instructions for the support systems) are intended for health care professionals who use, clean, disinfect and sterilize the MIMLED. The installation instructions for the holding systems are intended for qualified and trained technical personnel.

KEY PERFORMANCE FEATURES

The lights are used to supply lighting for examination or surgical areas.

INTENDED USE

MIMSAL MIMLED 600 and MIMLED 1000 are designed for non-invasive, superficial illumination of the entire human body in the visible spectral range for the purpose of examinations, outpatient and inpatient treatments, and surgical procedures by medical professionals. The illumination is used only for optimum visibility of the examination or surgical area and has no diagnostic or therapeutic effect. Illumination is external to the body and the equipment does not come into contact with patients. The MIMLED are intended for use in all rooms used for medical purposes (group 0, 1, 2) – especially operating rooms.

INDICATION

The MIMLED are used to illuminate examination or surgical areas to support in diagnoses and treatments, especially during surgical operations. The light itself has no diagnostic or therapeutic effect.

CONTRAINDICATION

The MIMLED should only be used in operating rooms in conjunction with an uninterruptible power supply and fail-safe backup unit.

The products must not be used in the vicinity of strong magnetic fields (e.g. magnetic resonance tomographs).

Use of the equipment in oxygen-enriched atmospheres and in the vicinity of flammable anesthetic gases is prohibited.

If several lights are operating together, make sure that the total irradiance does not exceed 1000 W/m² to avoid excessive heat generation in the operating area.

ESIDUAL RISKS – RISK IN THE EVENT OF DAMAGE TO THE LIGHT FIXTURE

Protect the light fixture from impacts. Collision with other objects can lead to failure of the light and/or damage to the housing and the support arm system, causing parts to fall.

The fixture does not include a fail-safe power supply. A power failure will cause the fixture to shut down.

INCIDENTS AND REPORTS

The lighting systems must be reported to the competent authority in case of serious incidents. Even the possibility of causal involvement of the medical device in a serious incident is subject to reporting. According to the Medical Devices Regulation (MDR), the notification must be reported to the competent authority without delay.

3. OPERATION

3.1 CHECK BEFORE EACH USE

1. Check the system for visible deformation. If such are detected, contact service immediately.
2. Ensure that the system has the required hygiene status for use.
3. Before each startup, the entire unit must be checked for proper functioning. The unit should be moved in each degree of movement while checking the main function and the control system.
4. If a lamp head is too difficult to move or no longer holds its position, the holding tensions can be adjusted according to the operating instructions for supports and stands.
5. Check handle for cracks.



Do not operate the fixture if there is any doubt about its electrical safety or static and dynamic stability.

3.2 OPERATION OF THE LAMP HEAD

The simple and ergonomic operating concept of the MIMLED enables intuitive operation by the user.

The lamp head is connected to the support system via a bracket. The lamp head support allows the light to rotate approximately 270° in its holder.

The 360° joint on the support system allows rotation around the horizontal axis.

The sterilizable handle allows both positioning of the lamp head and brightness adjustment of the light during use.

Turning the sterilizable handle counterclockwise increases the illumination, while turning it clockwise reduces it.

The blue "sterile handle" (the assembly consists of a sterilizable handle and clip) for the MIMLED is not supplied sterile and must be disinfected and sterilized before first use.

The brightness indicators above the handle pulsate in standby mode with the lowest value indication LED.



The light automatically goes into standby mode as soon as mains power is connected. To completely switch off the light, the following must be taken into account, depending on the type of installation:

Mobile stand: Pulling the mains plug switches the light off completely.

Wall mount: Pulling the wall power supply switches the light off completely.

Ceiling mount: Switching off the current-carrying socket by means of switch provided by customer.

3.2.1 OPERATION OF THE LAMP HEAD

The controls for switching on and off (position 3) and for brightness control (position 6) are integrated into the top of the lamp head. The handle allows you to adjust the luminosity by turning the handle.

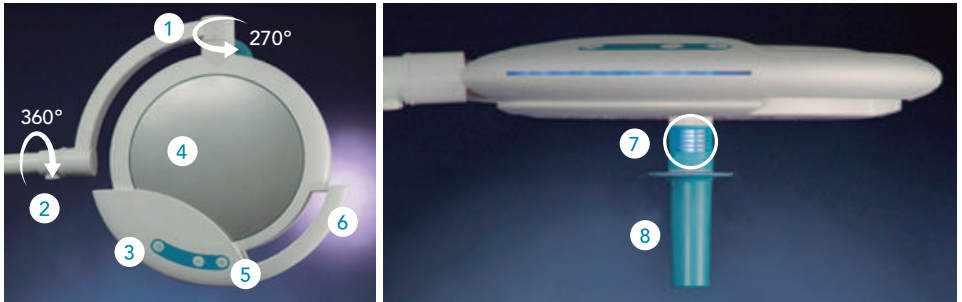

Figure. Schematic representation of the MIMLED 600 | MIMLED 1000 lamp head.

- 1 270° joint.
- 2 360° joint/interface. Support system allows rotation around the horizontal axis.
- 3 ON/OFF switch.
- 4 Heat sink.
- 5 Adjust brightness in 6 (MIMLED 600) or 10 (MIMLED 1000) steps: (+) increase the illuminance level and (-) decrease the illuminance level.
- 6 Lateral handle strip (for non-sterile operation and positioning of the lamp head).
- 7 Illuminance display (visualizes the current setting of the illumination in 5 steps).
- 8 Sterilizable handle with quick start and bright-ness control.

3.2.2 QUICK START VIA STERILIZABLE HANDLE

For time-critical applications (e.g: trauma room), the light can be turned on with a slight twist of the sterilizable handle. The direction of rotation is independent of this. The light starts at the lowest brightness (10.000 lux) and can thus also be easily started and operated in a sterile manner. After the procedure, the light must be switched off using the non-sterile ON/OFF button on the top of the housing.

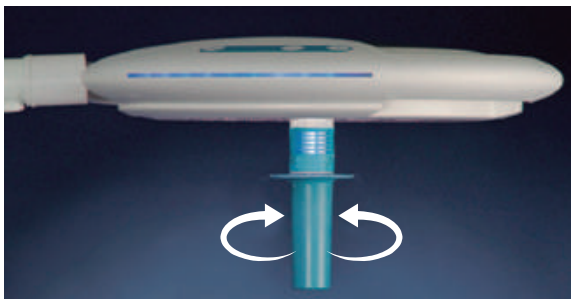

Figure. Schematic representation of the lamp head

3.3 WORKING AREAS OF THE SUPPORT SYSTEMS

3.3.1 MOBILE STAND MODEL

Use of the mobile stand in conjunction with the lamp head allows 360° rotation around the horizontal axis.

The swivel arm of the stand support is mounted vertically and enables a rotation of 60° around the vertical axis via the swivel joint.



Only use the stand support on a level and solid surface.

Once the stand support has been positioned, lock both stand rollers using the brakes.

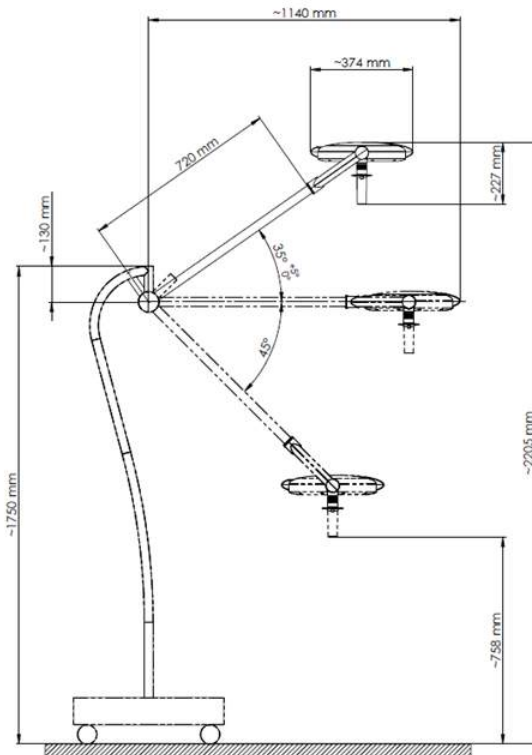

Figure. Schematic representation of the mobile stand

3.3.2 CEILING MOUNT MODEL

The arms of the ceiling mount are mounted vertically and allow a rotation of $2 \times 360^\circ$ around the vertical axis via the swivel joints.

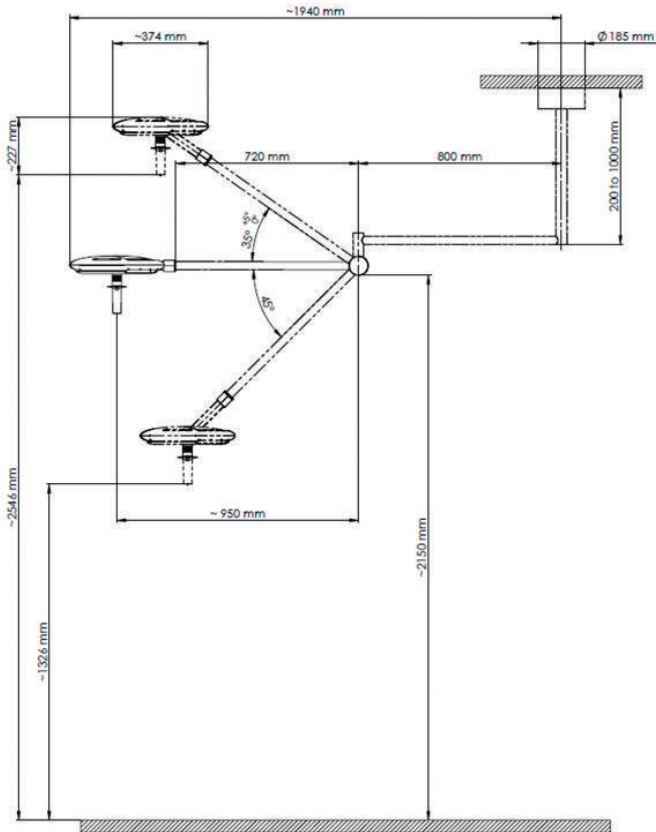
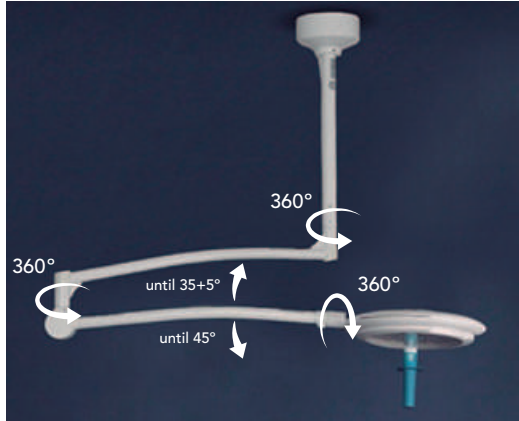

Figure. Schematic diagram of ceiling attachment

3.3.3 WALL MOUNT MODEL

The arms of the wall mount are mounted vertically and allow a rotation of 360° between the arms and 180° on the wall around the vertical axis via the swivel joints.



Do not attach any additional loads to the lamp head or stand/support.

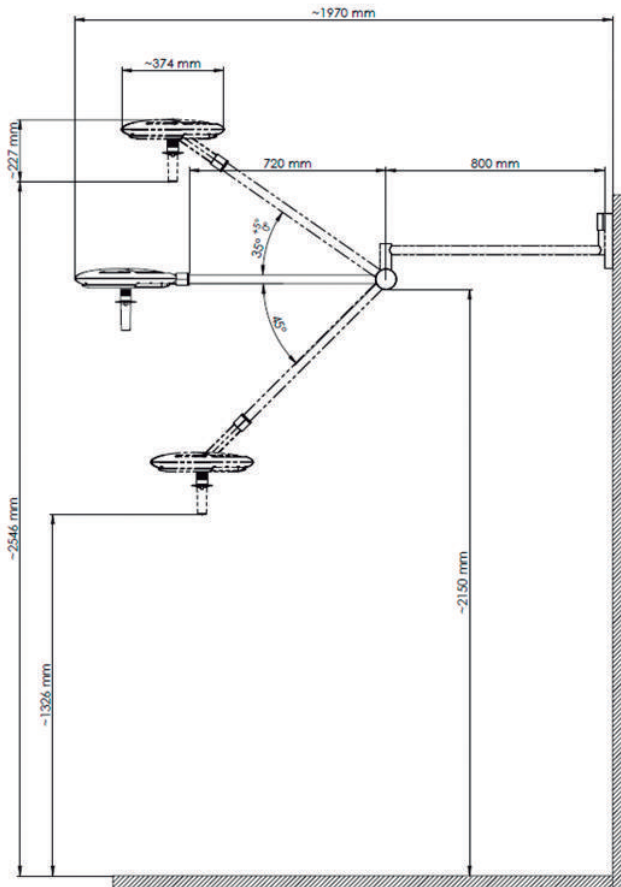
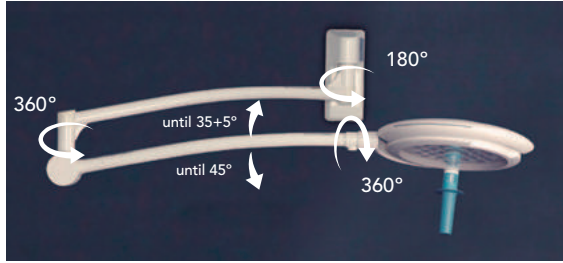

Figure. Schematic diagram of wall mount

4. SAFETY FUNCTIONS

The MIMLED minor surgical lights have built-in safety functions to protect the user and patient during operation.

4.1 PROTECTION AGAINST OVERHEATING



In the event that the circuit board overheats ($T > 75^{\circ}\text{C}$), the light will switch to an emergency lighting mode, with maximum illuminance limited to 40,000 lux. At the same time, the indication lights for the brightness display will flash. If the temperature rises even further ($T > 80^{\circ}\text{C}$), the surgery lamp will turn off completely by means of a built-in safety switch. The light will automatically turn on again only when the board temperature is below 50°C again.



WARNING: If the circuit board overheats, the heat sink on the top of the light can become very hot. In this case, only touch the white plastic handles! There is a risk of injury due to burns!

4.2 UNDERVOLTAGE



In the event of a drop in mains voltage, the light will initially attempt to continue operating with reduced voltage. When the supply voltage drops below 16 volts (normal: 24 volts), the light automatically turns off and the brightness indicator lights start flashing.

As soon as the mains voltage is restored, the light switches itself back on and adopts the last set parameters (brightness/color temperature).

4.3 POWER OUTAGE



In the event of a complete power failure, the light will go out. As soon as the mains voltage is restored, the light switches itself back on and adopts the last set parameters (brightness/color temperature).

4.4 ELECTRICAL DEFECT

The light has a function for monitoring the memory electronics. In the event of a defect, arbitrarily incorrect or potentially dangerous illuminance levels could occur, which is why the light performs a memory self-test at regular intervals. This does not take any additional time and runs during operation.



If memory errors occur, the light first uses the last valid memory sector and continues to operate properly. If there is a complete failure of the memory modules, the light switches off for safety reasons and is to be regarded as defective. When the ON/OFF switch is pressed, the brightness indicator lights flash 5x to indicate a complete failure of the light. The light cannot be operated in this state!



NOTE: In this case of error, please contact the service department to order a replacement of the control board!

5. EQUIPOTENTIAL BONDING CONDUCTOR

An equipotential bonding conductor is an additional conductor (accessory; not included in the scope of delivery) that establishes a direct connection between the electrical unit and the equipotential bonding busbar of the electrical installation. The mobile light on a mobile stand as well as the wall-mounted lights have a PE connection on the housing of the mobile stand or on the wall mount, respectively, so that possible potential differences that can occur as voltage sources are avoided in the patient environment, including in connection with parallel use of other units. Such voltage sources can cause currents via the body resistance that not only flow over the patient, but can also affect or even endanger doctors and nursing staff. Active medical devices may malfunction due to such outflowing currents.

In class 2 rooms used for medical purposes, in addition to the protective measures according to DIN VDE 0100 Part 410, all external conductive parts within the patient environment are connected (electrically to each other and) to the equipotential bonding busbar. This means that the equipotential bonding conductor must be connected to an equipotential bonding busbar.

To ensure that the permissible touch voltage of 10 mV is not exceeded ($\Delta u \leq 10\text{mV}$), potential equalization (PE) must be performed. For this purpose, the PE conductor (see Accessories list) of the light must be connected to the PE busbar.



NOTE: For wall-mounted lights, the protective earth conductor serves only as a functional earth (protection class II).

For ceiling-mounted lights, an on-site equipotential bonding conductor must be connected to the respective ceiling panels when installed in class 2 rooms used for medical purposes, as also mentioned in the respective installation instructions.



Figure. PE connection socket on mobile stand



Figure. PE connection socket on the mobile stand with the green/yellow equipotential bonding conductor



Figure. PE connection socket on the mobile stand with the green/yellow equipotential bonding conductor

6. REPROCESSING OF STERILE ACCESSORIES

The cleaning and disinfection procedures described here have been developed and validated in accordance with the recommendations of the medical societies and the associated standards. In addition to the procedures mentioned here, please also observe your facility's internal hygiene regulations for cleaning, disinfection and sterilization of medical devices.

6.1 STERILIZABLE HANDLE

The MIMLED lights are equipped with a blue sterilizable handle (sterile handle) as standard. The removable handle is steam sterilizable up to 134 °C.



The blue sterilizable handle must be sterilized before initial use and before any further use in a sterile environment. Otherwise there is a risk of cross-contamination!



Figure. Sterilizable handle

The handle must be removed for sterilization:

To remove, press the two release buttons on the side and pull the sterilizable handle downward.

To attach, slide the handle on until the latch on the side release buttons audibly engages.



During surgery, the hand grips often become unsterile; keep additional hand grips on hand for replacement (consists of Art. No. ML4500.04-020). Only use handles from MIMLED. Handles from other manufacturers are not authorized!

1 Side release button.

6.2 DISINFECTION

The sterile handle must be cleaned and disinfected after use. A mechanical process (disinfector) should be used for cleaning/disinfection.

The following mechanical procedure was validated for effective cleaning/disinfection of the sterile handle using the WD 290 washer-disinfector from Belimed, program 1 (instruments alkaline):

Pre-cleaning	3 min. pre-rinse
Cleaning	5 min at 48 °C, followed by 2 min cold rinse and rinse with deionized water
Disinfection	5 min. at 93 °C
Drying	15 min. at 95 °C
Cleaner	Mediclean forte, Dr. Weigert company

Table. Disinfection

6.3 STERILIZATION

Sterilization may only be performed on handles that have already been cleaned and disinfected. The sterilization of the blue sterile handle has been validated with the following mechanical procedure and parameters:

Sterile handle packaged in paper/laminate

Sterilizer class B LISA 522, serial number 08-0794, W&H company

Sterilization process: Fractionated pre-vacuum process

Temperature: 134 °C

Holding time: 18 min.

Table. Sterilization



WARNING: ONLY FOR STEAM STERILIZATION!

If a sterilization process other than the one described is used, the suitability and basic effectiveness of the process must be validated by the user.

6.4 VERIFICATION/DURABILITY

Before reuse, the handles must be checked for damage and replaced as necessary. The handles are designed for 1000 reprocessing cycles and must be replaced every two years. Please refer to the embossing on the top of the handle to determine the date of manufacture.



If the handles are used beyond the stated specifications (1000 cycles or 2 years), the responsibility lies with the user. In this case, there is a risk that the handle will break during operation and fragments could enter the operating area!

6.5 SIGNS OF MATERIAL WEAR

Material wear is normally the result of sterilization, disinfection and damage during use. After sterilization/disinfection and use, inspect the light for corrosion, damaged surfaces, scratches, sharp edges, breaks as well as contamination of the handle and sort out the damaged unit. Critical areas such as the lamp head housing, handles, stands, joints, power supply units, power connection must be inspected particularly carefully.

If there is visible material wear or damage even though the light is functioning, disconnect the unit from the power supply and immediately contact the manufacturer/provider for service and advice.

7. CLEANING/DISINFECTION

7.1 7.1 GENERAL SAFETY INSTRUCTIONS

1. Disconnect the light from the mains before disinfection.
2. Do not use spray cleaner and/or spray disinfectant. Do not spray liquid into sockets or unit openings or allow liquid to penetrate them



WARNING: ELECTRIC SHOCK

The units may carry electricity and must be handled with care during cleaning and disinfection.

7.2 CLEANING

SAFETY

Please observe the general safety instructions.

RECOMMENDED CLEANING

1. Use a mild soap solution or commercial dishwashing liquid as a cleaning agent.
2. Wipe surfaces with a slightly damp cloth, adding a little mild soap solution (dishwashing liquid) if necessary.
3. Finally, thoroughly wipe the outer surfaces dry with a soft, clean (if necessary anti-static) cloth (e.g. with an ASC™ anti-static cloth).



WARNING: RISK OF INFECTION AND CONTAMINATION FOR PATIENTS

Solvents can corrode plastics Strong acids, alkalis and agents containing more than 60% alcohol can cause plastics to become brittle. Damaged parts can fall into open wounds. If cleaning fluid enters the support/support system and accessories, it is possible for the excess solution to enter open wounds.

7.3 DISINFECTION

SAFETY

Please observe the general safety instructions.

DISINFECTION PROCESS

The standardized disinfection procedure for the MIMLED light system is wipe disinfection. Hygiene guidelines and corresponding safety measures for the disinfection processes to be used must be defined by the operator.

The tested and validated disinfectant MELISEPTOL© from the manufacturer Braun Melsungen is recommended. Adhere to protective measures. Observe the instructions of the disinfectant manufacturer. Observe hygiene guidelines.



Perform surface disinfection every working day! After contamination by potentially infectious material (e.g. blood, secretion or excrement), disinfect surfaces immediately, targeting these areas especially.



Contact your hygiene specialist for coordination of disinfectant and procedures in connection with your internal requirements regarding the current hygiene status! Carry out disinfection in accordance with the internal disinfection plan!



WARNING: HEALTH HAZARD

Disinfectants may contain harmful substances that can cause injury to skin and eyes or damage respiratory organs if inhaled.

8. MAINTENANCE

Medical devices must be subjected to regular maintenance and testing cycles. This is fundamental for compliance with safety concerns.

The manufacturer of the medical device is responsible for defining regular safety measures. The operator is responsible for implementing these defined measures.



NOTE: Always switch the light to standby mode and disconnect the power plug or disconnect the light from the power supply before carrying out any maintenance or inspection work. Secure the light against unintentional restarting.



WARNING: RISK OF INJURY!

Support arm is spring-loaded and can spring up when the lamp head is removed.



When carrying out maintenance work, follow the manufacturer's instructions for installation/dismantling (see chapter 12.6).

8.1 SUPPORT SYSTEMS

All support systems must be checked by the operator for the following points:

- Every six months:
 1. Deformations of the support system
 2. Cracks on plastic parts
 3. Paint damage
- Yearly:
 1. Extended check of the support system, e.g. holding force of the spring arm, check fastening screw on underside of stand base and tighten if necessary.
 2. Extended functional test such as ease of movement of the joints.
 3. Electrical safety testing.

In the event of any malfunctions or damage, please notify your supplier.



WARNING: ELECTRIC SHOCK

Disconnect the unit from the power supply during all testing work.

8.2 LAMP HEAD

The following inspections/maintenance must be performed annually:

1. Checking for cracks, deformations in plastic parts and seals.
2. Electrical safety testing.
3. Extended function test.
4. Paint damage.

9. DISPOSAL

The light may be operated for a maximum of 10 years after initial commissioning. The unit should then be taken out of service and disinfected and cleaned for disposal. Therefore, for proper disposal, contact an approved disposal company. For proper disposal of the system, please contact an authorized disposal company.



NOTE: Do NOT disassemble the spring arms and articulated joints. Some of the spring arms and joints contain pretensioned compression springs which can release their tension abruptly if they are not dismantled properly.



NOTE: Do not dispose of the product with normal domestic waste.



Perform all disinfection or sterilization measures prior to decommissioning to exclude contamination of the environment.

10. MOUNTING THE LAMP HEAD

10.1 LAMP HEAD ASSEMBLY



Figure. Lamp Head accessorie

Security element.

MOUNT LAMP HEAD



1. Disconnect the power plug and secure it against reconnection.
2. Remove the protective flap from the spring arm opening.



WARNING: RISK OF INJURY!

The spring arm, which is pressed down, can spring up and cause injuries. No persons are allowed to be within the swivel range of the spring arm while the end unit is being mounted.



3. Slide the plastic sleeve onto the arm so that the two slots are aligned.
4. Slide in the swivel arm end of the lamp head (remove the grease protection cover first).

MOUNT LAMP HEAD



5. Insert the locking segment fully into the slot so that the locking segment can be inserted into the groove.



6. Turn plastic sleeve by 180° and tighten slotted screw.
7. Check that the end unit is securely seated.

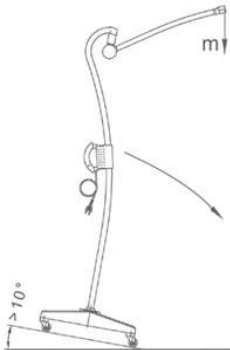

Figure. Tilt test of mobile stand



CAUTION: DAMAGE TO THE UNIT

After mounting the lamp head, perform a tilt test according to DIN EN 60601-1.

10.2 MOBILE STAND ASSEMBLY

10.2.1 MOUNT ROLLERS



WARNING: STATIC CHARGE

If the PE cable is not fitted, the stand unit may become statically charged and discharged onto patients. Mount the PE cable.



CAUTION

Always attach the braked rollers diagonally, otherwise there is a risk of tipping or slipping.



Figure. Rollers

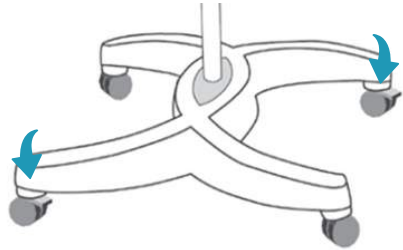
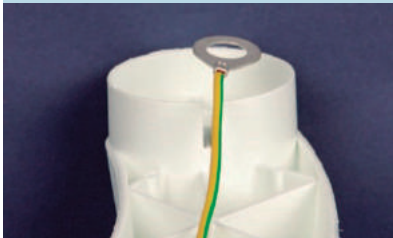

Figure. Brakes

MOUNT ROLLERS



1. Ring cable lug in PE cable.
2. Guide two antistatic rollers with brakes through the ring cable lug of the PE cable.



3. Press the two antistatic rollers with brakes.



4. Insert fully into the tripod base.

MOUNT ROLLERS



5. Fully insert two rollers without brakes.
6. Check that the rollers are securely seated.

10.2.2 MOUNT STAND TUBE



CAUTION: DAMAGE TO THE UNIT

Without engaging the nose lock and then screwing the stand tube, the stand will fall over. Engage nose lock and tighten screw with spring washer.

Take the roller base as described in the previous chapter and mount the stand tube as follows:

MOUNT STAND TUBE



1. Unscrew the screw with spring washer from the roller foot.



2. Loosen the Phillips screw so that the canopy can be moved.



3. Insert the stand tube so that the recess in the tube sits in the nose of the stand base and can no longer be turned.

MOUNT STAND TUBE



4. Insert the stand tube so that the recess in the tube sits in the nose of the stand base and can no longer be turned.



5. Check for secure seating.



6. Screw in the screw with spring washer again and tighten it firmly.



7. Press plastic half rings with sealing ring into the stand base. Tighten the Phillips screw and check that it is securely seated.

10.2.3 MOUNT SAFETY RING

Accessories included: washer (left); with collet of the housed circlip (right).



Figure. Accessory spring arm



CAUTION: DAMAGE TO THE UNIT

Without the washers mounted, the circlip becomes unscrewed and the spring arm falls out of the connection. Always mount the washer.

Use of circlip pliers with over-expansion guard

The illustration shows an example of circlip pliers with over-expansion guard (1).

The over-expansion guard prevents over-expansion of the circlip.

The circlip must not be dismantled without circlip pliers with over-expansion guard (1).

Follow the next steps:

1. Turn the adjusting ring (2) of the circlip pliers (1) until the circlip has an over-expansion guard of approx. 8 mm as shown in the illustration.
2. This corresponds to an expansion of the circlip inner diameter of max. 32mm.

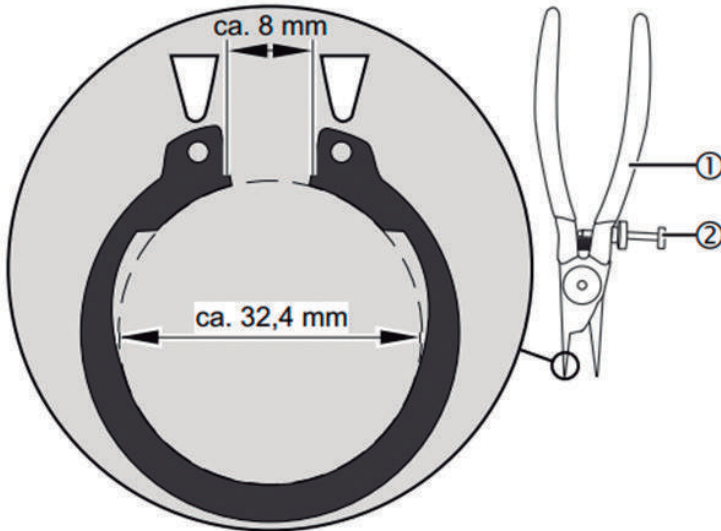

Figure. Use of circlip pliers with over-expansion guard

Disassemble/assemble circlip using circlip pliers with over-expansion guard



WARNING

An overexpanded circlip can cause the support arm system to crash:

- Carefully expand the circlip (1) only so far that it can just be guided over the trunnion (2).
- To do this, expand the circlip (1) to a maximum inner diameter of 32.4mm. This corresponds to an inner dimension of approx. 8mm between the eyelets.

1. Insert circlip pliers with over-expansion guard into the eyelets of the circlip (1).
2. Carefully expand the circlip (1) so that it can just be guided over the trunnion (2).
3. Carefully remove the circlip (1).
4. Mark circlip (1) for single use and keep for later assembly.

In the event of service or maintenance, a new, unused circlip must always be fitted.

Insert circlip pliers with over-expansion guard into the eyelets of the circlip (1).

The circlip must lie fully and straight in the groove provided. This is checked by the following steps: The circlip (1) must audibly engage in the groove on the trunnion.



Acoustic test

- The circlip (1) must audibly engage in the groove on the trunnion.

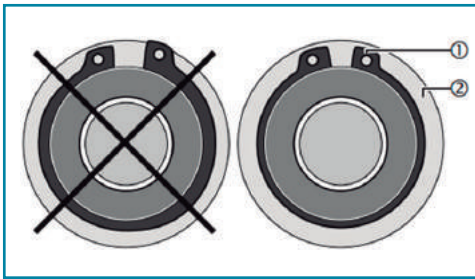

Visual inspection

- The washer $\varnothing 39$ mm (2) must be mounted under the circlip (1).
- The circlip (1) must not be non-circular.
- The distance between the two eyelets in the circlip (1) must correspond to the distance in the unstressed state. A higher distance indicates that the circlip is not mounted correctly.

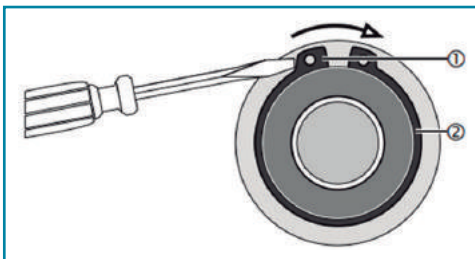

Rotating the circlip in its groove

- Place a small, suitable screwdriver on the eyelet (1) of the circlip (2) and carefully turn the circlip (2) in the direction of the arrow.
- Be careful not to widen the circlip (2) or push it out of the groove.

Figure. Mount circlip

10.2.4 MOUNT SPRING ARM

MOUNT SPRING ARM



1. Unscrew the Phillips screw.



2. Remove the cover cap to the front and upwards.



3. Insert spring arm pin.



4. Push in as far as it will go.

MOUNT SPRING ARM



5. Place the washer and secure it with the circlip. The circlip must fit into the groove of the trunnion. This should be checked. (See chapter "10.2.3 Mount Safety Ring").



6. Establish electrical plug connection.



7. Carefully insert the connection into the tube.



8. Put on the cover cap.



9. Screw the cover cap with the Phillips screw.

10.2.5 ADJUST SPRING FORCE

Like any technical component, springs are subject to natural wear. Thus, the spring force may decrease after longer operation and must be readjusted.

Adjust the spring force so that the spring arm with end unit remains in any desired position.



CAUTION: DESTRUCTION OF THE SPRING ARM

The spring force is adjusted in the upper end position.

ADJUST SPRING FORCE



1. Remove the joint cover on the left from the direction of the end unit on the spring arm. To do this, carefully lever the joint connection out of the groove in the spring arm joint using a narrow slotted screwdriver.
2. Move the end unit to the upper end position.



3. Insert slotted screwdriver into the hole.
4. Adjust spring force.



5. Affix the joint cover and snap it into place.



CAUTION: DESTRUCTION OF THE SPRING ARM

Screwing in the adjusting screw too deeply will destroy the spring arm. Carefully screw in the adjusting screw while repeatedly checking the braking force:

- If the spring arm lowers - the spring force is too low:
The adjusting screw must be turned to the left (counterclockwise).
- If the spring arm rises - the spring force is too high:
The adjusting screw must be turned to the right (clockwise).

Use the same procedure for the ceiling and wall mount!

10.2.6 REPLACING FUSES



WARNING: ELECTRIC SHOCK

For all maintenance work, disconnect the unit from the power supply, pull out the power plug and secure the unit from being switched on again.



CAUTION: DAMAGE TO THE UNIT

Only the specified fuses (see chapter 12, "Technical Data", page 44) may be used.

REPLACE THE FUSES ON THE MOBILE STAND



1. Loosen the Phillips screw, but do not unscrew it completely.



2. Push up and secure the clamping ring, seal and housing.



3. Remove the defective fuse.



4. Replace defective fuse.



5. Insert new fuse.

11. MOUNTING THE WALL FIXTURE AND CEILING FIXTURE



NOTA

1. Structural analysis must be carried out before mounting the wall or ceiling fixtures!
2. The load-bearing capacity of the structure must be designed, checked and secured by a structural engineer.
3. The applicable regional building regulations must be observed.
4. In case of incorrect drilling, e.g. by drilling into a reinforcement bar, the responsible structural engineer must be consulted, as the sufficient static load distribution in the ceiling may be endangered!

DECLARATION OF ACCEPTANCE

This is to certify that the load-bearing wall/ceiling and anchorage for the MIMLED secure and load-bearing.

PROJECT

.....

.....

.....

ANCHORING

With counter-plate

Other

LOCATION

.....

.....

Signature/Stamp
Structural engineer / Building authority

11.1 CHOICE OF FASTENERS



NOTE

1. The person responsible for the installation is responsible for the safe selection of the fasteners and the safe execution of the fastening.
2. For lightweight walls, we recommend fastening with a counter-plate (not included in delivery).



WARNING: LOAD DATA

- The load torque on the spring arm of the wall mount must not exceed 39 Nm.
- The load torque on the spring arm of the ceiling mount must not exceed 30 Nm.
- No safety factors are included in the specified load data. The prescribed regional safety factors shall be included.
- The load data of the wall and ceiling unit can be taken from the following table.

LOAD DATA FOR WALL MOUNT

Load torque wall mount	110 Nm
Vertical weight force	97 N
Pull-out force per wall plug (total 2 pcs.)	624 N

LOAD DATA FOR CEILING MOUNT

Load torque ceiling mount	85 Nm
Vertical weight force	147 N
Pull-out force per wall plug (total 4 pcs.)	405 N





Table. Load data for wall and ceiling mount

11.2 WALL MOUNTING



NOTE: A properly grounded socket in the area of the connection line is required for the mains connection of the wall mount.

ACCESSORIES

	Washer		1x 4520.12r008/00 Switching power supply
	Tab washers		
	Circlip held on collet		1x 4520.12-006/00 Bend protection sleeve White 1x 4520.12-004/00 Strain relief clamp 14.42.770 2x 4520.20-007/00 Connection terminal two-pole with lever 2x 0606.01-004/00 Hexagon nut DIN EN 24035 M4-04 1x 4510.20-014/00 Folding ferrite WE 74271131

WALL MOUNTING



1. Loosen the side screws on the plastic cover



2. Remove the lower plastic cover.



3. Remove the upper plastic cover.

4. Drill two holes according to the specifications of the manufacturer of the fastener (see page 43).

5. Insert fasteners flush.



NOTE: Do not proceed with installation until the binder has cured.

6. Insert fasteners into the two holes and screw on the wall bracket vertically so that the trunnion end points towards the floor.



7. Slide the white bend protection sleeve over the cable end of the plug-in power supply.

WALL MOUNTING

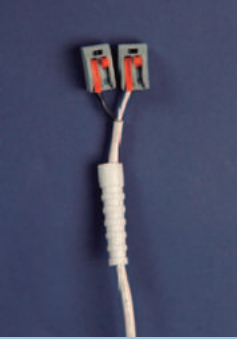

8. Attach the two-pole connection terminal (with lever) so that there is a connection terminal on each of the white and black ends of the cable.



9. Open the folding ferrite and place the cable in one half.



10. Close the folding ferrite.



11. Fasten the plug-in power supply cable to the wall bracket with a strain relief clamp.

WALL MOUNTING



12. Unscrew the Phillips screw and pull the cover cap forward and remove it upward.



13. Push the cable of the extension arm through the trunnion and insert the extension arm with spring arm onto the trunnion of the wall bearing.

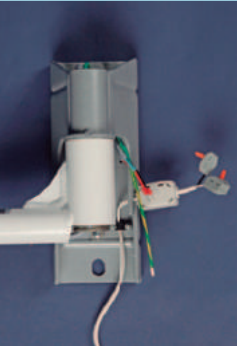

14. Mount the washer, then the tab washer and then the circlip on the trunnion of the wall bearing.
15. Insert the cable ends of the extension arm behind the trunnion in the direction of the floor.

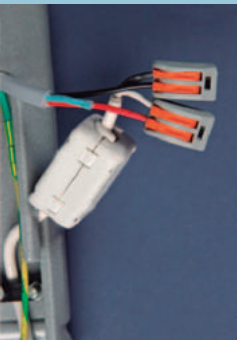

16. Fasten the red cable on the extension arm side in the connecting terminal of the white plug-in power supply cable. Accordingly, attach the black cable on the extension arm side to the connecting terminal of the black plug-in power supply cable.

WALL MOUNTING

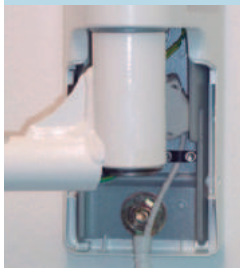

17. Push the upper plastic cover part back up and put it on.



18. Screw the green-yellow cable from the extension arm, as well as the green-yellow cable from the PE connection in the cover flap to the wall bearing bracket.



19. Insert the bend protection sleeve from the plug-in power supply unit into the recess.



20. Put on the housing cover and tighten it on the right and left with one Phillips screw each.



21. Put on the cover cap of the extension arm and tighten it with a Phillips screw.

11.3 MOUNTING THE CEILING FIXTURE

11.3.1 MOUNTING CEILING PANEL



WARNING: ELECTRIC SHOCK

Disconnect the on-site power supply from the mains and secure it against being switched on again.

MOUNT CEILING PANEL



1. Remove the protective.



2. Loosen the three setscrews.

3. Remove canopy, mark holes with the drilling template (page 43).

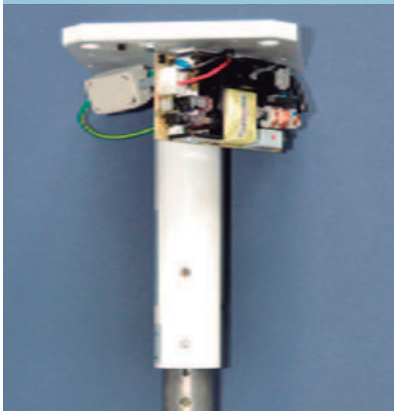

4. Drill four holes according to the specifications of the manufacturer of the fastener.

5. Insert fasteners flush with ceiling.



NOTE: Do not proceed with installation until the binder has cured.

6. Insert the fastener into the four holes and screw on the ceiling panel.

7. Align ceiling panel horizontally, check for secure seating.



8. Put on the canopy and tighten it with the three setscrews.

11.3.2 MOUNTING EXTENSION ARM WITH SPRING ARM

MOUNT SPRING ARM



1. Unscrew the Phillips screw.



2. Remove the plug



3. Push the extension arm with the spring arm onto the trunnion of the spacer tube.



CAUTION: RISK OF INJURY

Without the washer and tab washer in place, the circlip can loosen. The unit may fall out of the connection and cause injuries.

Always attach the washer and the tab washer.

MOUNT SPRING ARM



4. Put on the washer.



5. Apply the tab washer.



6. Insert the tab washer into the hole and slide the washer over the tube.



7. Pick up circlip with collet.



8. Mount circlip.

9. Check that the extension arm with spring arm is securely seated.



10. Position the plug straight and push it into place using slight pressure in the direction of the extension arm and the tube.



11. Tighten the plug with the Phillips screw.



WARNING: ELECTRIC SHOCK

Damaged electrical components (cables, plugs, etc.) can cause the support arm system to become electrically live. Touching live parts can lead to a life-threatening electric shock.

11.3.3 REPLACING THE FUSE OF THE CEILING MOUNT

REPLACING THE FUSE OF THE CEILING MOUNT



1. Loosen the three set screws with a screwdriver.
2. Pull down canopy.

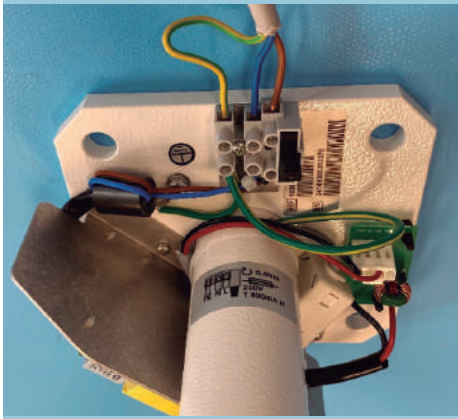

3. Remove and replace the defective fuse.
4. Insert new fuse.
5. Push the canopy back up and tighten the three set screws with a screwdriver.

11.4 ADJUST SPRING FORCE

Like any technical component, springs are subject to natural wear. Thus, the spring force may decrease after longer operation and must be readjusted.

Adjust the spring force so that the spring arm with end unit remains in any desired position.



CAUTION: DESTRUCTION OF THE SPRING ARM

The spring force is adjusted in the upper end position.

ADJUST SPRING FORCE



1. Remove the joint cover on the left from the direction of the end unit on the spring arm. To do this, carefully pry the joint cover out of the groove in the spring arm joint using a narrow slotted screwdriver.
2. Move the end unit to the upper end position.



3. Insert slotted screwdriver into the hole.
4. Adjust spring force.



5. Mount the joint cover and snap it into place.



CAUTION: DESTRUCTION OF THE SPRING ARM

Screwing in the adjusting screw too deeply will break the spring arm.

Carefully screw in the adjusting screw while repeatedly checking the braking force.

- **If the spring arm drops - the spring force is too low:**
The adjusting screw must be turned to the left (counterclockwise).
- **If the spring arm rises - the spring force is too high:**
The adjusting screw must be turned to the right (clockwise).

11.5 DRILLING TEMPLATE



NOTE: The dimensions shown on the drilling template are not on scale!

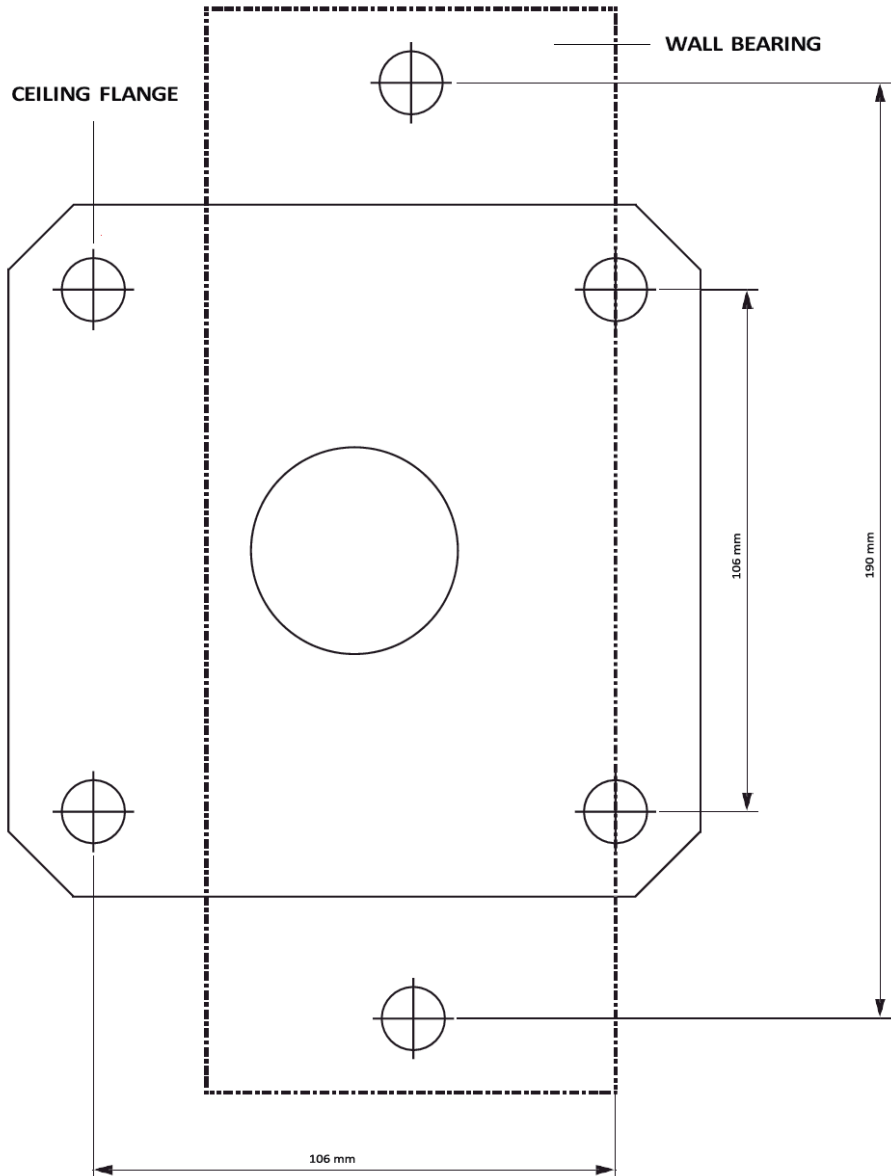

Table. Drilling template for ceiling and wall support

12. DATA

12.1 PHOTOMETRIC DATA FOR MIMLED 600 | MIMLED 1000

	MIMLED 600	MIMLED 1000
Maximum central illuminance at 1m [lux]	60.000	100.000
Illuminated field diameter at 1m D_{50}/D_{10} [mm]	140 / 210	140 / 210
Number of LEDs	15	15
Illuminance level distribution D_{50}/D_{10}	≥ 0,67	≥ 0,66
Illumination depth 60% [mm]	≥ 1010	≥ 1010
Color rendering index Ra	≥ 95	≥ 95
Color temperature [K]	4000	4000
Electronic brightness control on the handle	Standard dimming range between 10,000 and 60,000 lux in 6 levels, with 5 levels visualized on the handle	Standard dimming range between 10,000 and 100,000 lux in 10 levels, with 5 levels visualized on the handle
Special color rendering index R_9	≥ 90	≥ 90
Total irradiance level E [W/m ²]	220	390
Shading without screen [%]	100	100
Shading with one screen [%]	0	0
Shading with two screens [%]	66	63
Shading on the bottom of a standardized tube [%]	100	100
Shading on the bottom of a standardized tube and one screen [%]	0	0
Shading on the bottom of a standardized tube and two screens [%]	66	63
LED lifetime [h]	≥ 50.000	≥ 50.000
Service life of medical device [years]	10	10

Table. Photometric data according to DIN EN 60601-2-41 for MIMLED 1000 and MIMLED 600. All measurements were made at a working distance of 1000 mm. The technical data are subject to certain fluctuations. For technical production reasons, the actual values may differ slightly from the above values. The values for Ra/R9 may have deviations of approx. ±10%. The values for the color temperature may have deviations of approx. ±200 K.

12.2 ELECTRICAL AND OTHER TECHNICAL DATA

	MIMLED 600	MIMLED 1000
Rated voltage	24V DC \pm 10%	24V DC \pm 10%
Rated current	1.0 A @ 24 V	1.0 A @ 24 V
IP	42	42
Power consumption	24 W	33W
Protection class	Class I	Class I
Unit for continuous operation	SI	SI
Tensión nominal	100 - 240 V AC	100 - 240 V AC
Frecuencia nominal	50/60 Hz	50/60 Hz
Max. possible power consumption of the power supply unit	60 W	60 W

	CEILING SUPPORT	MOBILE STAND
Fuse type	Primary 250 V; T 800 mA H; L 5x20 mm; IEC 60127	Primary 250 V; T 800 mA H; L 5x20 mm; IEC 60217 Secondary 250 V; M 2A; L 5x20 mm

Table. Electrical and other technical data

12.3 AMBIENT CONDITIONS

ENVIRONMENTAL CONDITIONS FOR OPERATION

Ambient temperature	de 10 °C a 40 °C
Relative humidity (non-condensing)	de 30% a 75%
Air pressure	de 700 hPa a 1060 hPa

ENVIRONMENTAL CONDITIONS FOR STORAGE AND TRANSPORT

Ambient temperature	de -25 °C a 70 °C
Relative humidity (non-condensing)	de 10% a 75%
Air pressure	de 500 hPa a 1060 hPa
Up to 15 weeks from the date of delivery, the previous storage conditions apply	

Table. Ambient conditions

12.4 PHYSICAL CHARACTERISTICS

Ref.	Model	Component	Net Weight	BOX DIMENSIONS			Gross Weight
				Length	Width	Height	
ML1000C 200	MIMLED 1000 CEILING 200mm	Headlamp 1000	2,58 Kg	580 mm	560 mm	190 mm	4,62 Kg
		Support 200	3,08 Kg	220 mm	220 mm	460 mm	4,08 Kg
		Arm	3,68 Kg	365 mm	995 mm	115 mm	4,88 Kg
ML1000C 400	MIMLED 1000 CEILING 400mm	Headlamp 1000	2,58 Kg	580 mm	560 mm	190 mm	4,62 Kg
		Support 400	3,89 Kg	220 mm	220 mm	650 mm	5,40 Kg
		Arm	3,68 Kg	365 mm	995 mm	115 mm	4,88 Kg
ML1000C 600	MIMLED 1000 CEILING 600mm	Headlamp 1000	2,58 Kg	580 mm	560 mm	190 mm	4,62 Kg
		Support 600	4,70 Kg	220 mm	220 mm	760 mm	6,24 Kg
		Arm	3,68 Kg	365 mm	995 mm	115 mm	4,88 Kg
ML1000C 800	MIMLED 1000 CEILING 800mm	Headlamp 1000	2,58 Kg	580 mm	560 mm	190 mm	4,62 Kg
		Support 800	5,52 Kg	220 mm	220 mm	1000 mm	6,98 Kg
		Arm	3,68 Kg	365 mm	995 mm	115 mm	4,88 Kg
ML1000C 1000	MIMLED 1000 CEILING 1000mm	Headlamp 1000	2,58 Kg	580 mm	560 mm	190 mm	4,62 Kg
		Support 1000	6,44 Kg	220 mm	220 mm	1140 mm	8,02 Kg
		Arm	3,68 Kg	365 mm	995 mm	115 mm	4,88 Kg
ML1000W	MIMLED 1000 WALL	Headlamp 1000	2,58 Kg	580 mm	560 mm	190 mm	4,62 Kg
		Support + Arm	5,64 Kg	110 mm	370 mm	1000 mm	7,40 Kg
ML1000FL	MIMLED 1000 TROLLEY STAND	Headlamp 1000	2,58 Kg	580 mm	560 mm	190 mm	4,62 Kg
		Arm	6,06 Kg	330 mm	190 mm	1740 mm	8,64 Kg
		Trolley Stand	3,68 Kg	365 mm	995 mm	115 mm	4,88 Kg
ML600C 200	MIMLED 600 CEILING 200mm	Headlamp 600	2,58 Kg	580 mm	560 mm	190 mm	4,62 Kg
		Support 200	3,08 Kg	220 mm	220 mm	460 mm	4,08 Kg
		Arm	3,68 Kg	365 mm	995 mm	115 mm	4,88 Kg
ML600C 400	MIMLED 600 CEILING 400mm	Headlamp 600	2,58 Kg	580 mm	560 mm	190 mm	4,62 Kg
		Support 400	3,89 Kg	220 mm	220 mm	650 mm	5,40 Kg
		Arm	3,68 Kg	365 mm	995 mm	115 mm	4,88 Kg
ML600C 600	MIMLED 600 CEILING 600mm	Headlamp 600	2,58 Kg	580 mm	560 mm	190 mm	4,62 Kg
		Support 600	4,70 Kg	220 mm	220 mm	760 mm	6,24 Kg
		Arm	3,68 Kg	365 mm	995 mm	115 mm	4,88 Kg
ML600C 800	MIMLED 600 CEILING 800mm	Headlamp 600	2,58 Kg	580 mm	560 mm	190 mm	4,62 Kg
		Support 800	5,52 Kg	220 mm	220 mm	1000 mm	6,98 Kg
		Arm	3,68 Kg	365 mm	995 mm	115 mm	4,88 Kg
ML600C 1000	MIMLED 600 CEILING 1000mm	Headlamp 600	2,58 Kg	580 mm	560 mm	190 mm	4,62 Kg
		Support 1000	6,44 Kg	220 mm	220 mm	1140 mm	8,02 Kg
		Arm	3,68 Kg	365 mm	995 mm	115 mm	4,88 Kg
ML600W	MIMLED 600 WALL	Headlamp 600	2,58 Kg	580 mm	560 mm	190 mm	4,62 Kg
		Support + Arm	5,64 Kg	110 mm	370 mm	1000 mm	7,40 Kg
ML600FL	MIMLED 600 TROLLEY STAND	Headlamp 600	2,58 Kg	580 mm	560 mm	190 mm	4,62 Kg
		Arm	6,06 Kg	330 mm	190 mm	1740 mm	8,64 Kg
		Trolley Stand	3,68 Kg	365 mm	995 mm	115 mm	4,88 Kg

12.5 ELECTROMAGNETIC COMPATIBILITY



Despite all measures, interference and or EMC problems may occur.
Therefore, please note the following tables!

Further information on electromagnetic compatibility:

1. Medical devices are subject to precautionary measures in accordance with EMC and must be installed and commissioned in accordance with the EMC information contained in the operating instructions.
2. Portable and mobile RF communications equipment can affect electrical medical units.
3. The use of stands and mounting systems that are supplied by other manufacturers is not permitted.

Emitted interference

GUIDELINES AND MANUFACTURER'S DECLARATION – ELECTROMAGNETIC EMISSIONS

The MIMLED 600 and MIMLED 1000 minor surgical lights are intended for use in an ELECTROMAGNETIC ENVIRONMENT as specified below. The user should ensure that the units can be operated in such an environment.

Note: Home health care environments have higher immunity requirements compared to professional healthcare facilities. Therefore, the requirements for professional health care facilities regarding immunity to interference are included.

Phenomenon	EMC basic standard	Immunity test level
		Environment in areas of home health care
Conducted and radiated interference emissions	IEC 61000-3-3	CISPR 11 Group 1, Class B
Harmonic distortion	IEC 61000-3-2	IEC 61000-3-2, Class A
Voltage fluctuations and flicker	IEC 61000-3-3	

Interference immunity

GUIDELINES AND MANUFACTURER'S DECLARATION – ELECTROMAGNETIC EMISSIONS

The MIMLED 600 and MIMLED 1000 minor surgical lights are intended for use in an ELECTROMAGNETIC ENVIRONMENT as specified below. The user should ensure that the units can be operated in such an environment.

Note: The environment in home health care settings has higher immunity requirements compared to professional healthcare settings. Therefore, the requirements for professional health care facilities regarding immunity to interference are included.

Phenomenon	EMC basic standard	Immunity test level
		Environment in areas of home health care
Static electricity discharge	IEC 61000-4-2	±8 kV contact ±2 kV, ±4 kV, ±8 kV, ±15 kV air
Fast transient electrical disturbances (Burst) EN 61000-4-4	IEC 61000-4-5	±2 kV 100 kHz repetition frequency
Surge voltage cable to cable	IEC 61000-4-5	±1 kV
Surge voltage cable to earth	IEC 61000-4-5	± 2 kV
Voltage dips	IEC61000-4-11	0% UT: 1 Period 70% UT: 25/30 periods
Magnetic fields with energy technology rated frequencies	IEC 61000-4-8	30 A/m
High-frequency electromagnetic fields	IEC 61000-4-3	80 MHz – 2.7 GHz, 10 V/M
Conducted interference induced by high-frequency fields	IEC 61000-4-6	150 kHz – 80 MHz 10 Vrms

Please note that the MIMLED 600 and MIMLED 1000 minor surgical lights will go out in the event of a power failure or mains voltage drop. If uninterrupted illumination is required, connect the lights to a power outlet with an emergency power function.

GUIDELINES AND MANUFACTURER'S DECLARATION – ELECTROMAGNETIC EMISSIONS

Note 1: For 80 MHz and 800 MHz, the higher frequency range applies.

Note 2: These guidelines may not be applicable in all cases. The propagation of electromagnetic quantities is affected by absorption and reflection of buildings, objects and people.

A - The field strength of stationary transmitters, such as base stations of radio telephones and land mobile radios, amateur radio stations, AM and FM radio and television transmitters, cannot theoretically be accurately predicted. To determine the ELECTROMAGNETIC ENVIRONMENT with respect to the stationary transmitters, a study of the electromagnetic phenomena of the site should be considered. If the measured field strength at the location where the light is used exceeds the ABOVE CONFORMITY LEVELS, the unit should be observed to demonstrate intended FUNCTIONING. If unusual performance characteristics are observed, additional measures may be required, such as changing the orientation or location of the light.

B - Over the frequency range 150 kHz to 80 MHz, the field strength should be less than 3V/m.

12.5.1 IMMUNITY TO HIGH-FREQUENCY ELECTROMAGNETIC FIELDS IN THE DIRECT VICINITY OF WIRELESS COMMUNICATION DEVICES

IMMUNITY OF THE MIMLED 600 | MIMLED 1000 MINOR SURGICAL LIGHTS TO ELECTROMAGNETIC FIELDS IN THE VICINITY OF WIRELESS COMMUNICATIONS DEVICES

The MIMLED is intended for use in an electromagnetic environment where RF interference are controlled. The customer or user of the light can help avoid electromagnetic interference by maintaining the minimum distance between portable and mobile RF telecommunication devices (transmitters) and the light, depending on the output power of the communication device, as indicated below.

Frequency [MHz]	Radio service	Modulation	Maximum power [W]	Distance [m]	Immunity test level [V/m]
380 to 390	TETRA 400	Pulse modulation 18Hz	1,8	0,3	27
430 to 470	GMRS 460, FRS 460	FM +- 5 kHz hub 1 kHz sine wave	2	0,3	28
704 to 787	LTE band 13, 17	Pulse modulation 217 Hz	0,2	0,3	9
800 to 960	GSM 800/900, TETRA 800, iDEN 820, CDMA 850, LTE band 5	Pulse modulation 18 Hz	2	0,3	28
1700 to 1990	GSM 1800, CDMA 1900, GSM 1900, DECT; LTE band 1, 3, 4, 25; UMTS	Pulse modulation 217 Hz	2	0,3	28
2400 to 2570	Bluetooth, WLAN 802.11 b/g/n, RFID 2450, LTE band 7	Pulse modulation 217 Hz	2	0,3	28
5100 to 5800	WLAN 802.11 a/n	Pulse modulation 217 Hz	0,2	0,3	9

12.6 MEASURES IN THE EVENT OF MALFUNCTIONS OR CHANGES IN PERFORMANCE

In the event of any malfunction or unforeseen change in performance of the fixture, immediately disconnect the fixture from AC power and discontinue fixture operation. Contact your dealer or our service centers for inspection and repair of the device.

12.7 INSPECTION PLAN FOR THE LAMP HEAD

SYSTEM DATA

Supplier

Date of installation

Serial number on the unit

Inventory number operator

Unit location



IMPORTANT INFORMATION

1. The inspection work must be carried out by trained service personnel.
2. The inspection intervals must be observed.
3. Service life in years - 10 years.
4. This inspection plan is only valid in conjunction with the operating instructions, which must be consulted in addition to the inspections.

The light system must be checked for the following points at the intervals specified below by a company authorized by MIMSAL or by personnel with appropriate qualifications

Visual and functional check (annually checkout)	1	2	3	4	5	6	7	8	9	10
All parts are free from cracks*										
The head is free from paint damage*										
The function is proper*										
Verification of electrical safety										
All identification plates available/legible										
Parts on the stand are deformation-free**										
Mobility of the stand**										
All joints operate smoothly**										
Height stop of the stand correct**										
Fuse segment of stand tested**										
Stand locking ring in position**										
Spring force set correctly**										
Assessment for collision damage**										
Tighten screw on stand base**										
Electrical test protective conductor**										
Electrical test leakage current**										

The work is to be carried out including the necessary adjustment work and safety inspection.

- * Damaged or deformed components should be replaced as a precaution. Please contact the supplier of the system.
- ** Should one of the marked points be defective during the test, the system must be shut down immediately as a precautionary measure in order to rule out further damage to people and equipment. Inform the supplier of the system immediately.

The medical device book that belongs to every medical device and is prescribed by the MPBetreibV must be kept on site. Service and maintenance work as well as safety checks must be documented in this medical device book. Test reports such as this must be filed in the respective medical device book.

Technical changes and errors excepted.

CONFIRMATION OF THE INSPECTIONS PERFORMED

1st year Date Signature / Stamp	6th año Date Signature / Stamp
2nd year Date Signature / Stamp	7th year Date Signature / Stamp
3rd year Date Signature / Stamp	8th year Date Signature / Stamp
4th year Date Signature / Stamp	9th year Date Signature / Stamp
5th year Date Signature / Stamp	10th year Date Signature / Stamp

MIMSAL

MIMSAL TRADE S.L.
C/ Mollet, 17
Polígono Industrial Palou Nord
08401 – Granollers (Barcelona) SPAIN
Tel. +34 930 139 860
mimsal@mimsal.com
www.mimsal.com

Rev. 04
16.01.2023